

MAXIMO

Okvirna oplata
s MX sidrom za jednostrano rukovanje

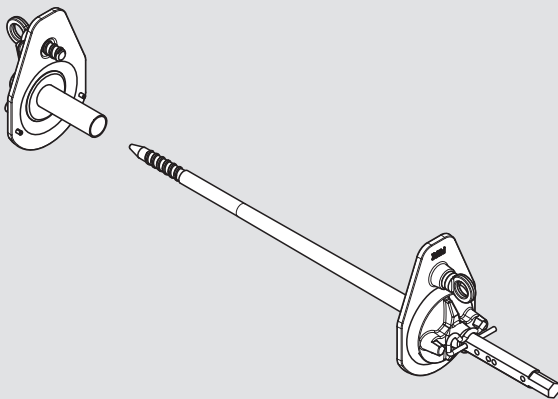

PERI MX sidro



Izdanje 11/2010

PERI GmbH
Formwork Scaffolding Engineering

P.O. Box 1264

89259 Weissenhorn

Germany

Tel. +49 (0) 7309.950-0

Fax +49 (0) 7309.951-0

info@peri.com

www.peri.com

Važne upute:

Prilikom primjene naših proizvoda u pojedinim zemljama treba voditi računa o aktualnim verzijama važećih zakona i sigurnosnih propisa.

Fotografije u ovoj brošuri aktualne su snimke jednog gradilišta. Zato se ne smiju smatrati konačnim, osobito sigurnosni detalji i detalji sidrenja.

Nužno je voditi računa o sigurnosnim uputama i podacima o opterećenju. Sve izmjene i odstupanja iziskuju poseban statički dokaz.

Tehničke izmjene u cilju poboljšanja uzimaju se s rezervom. Zadržano pravo na zabunu, greške u pisanju i tiskarske greške.

Sadržaj

MAXIMO

- 3 Okvirna oplata s MX sidrom za jednostrano rukovanje

Brže

- 4 zahvaljujući MX sidru kojim se rukuje jednostrano

Štedi vrijeme

- 6 sistematiziranim sidrenim pozicijama
8 reduciranim sidrenim pozicijama
9 smanjenom potrebom za radnim osobljem

MAXIMO

- 11 Manje radnih faza = brža montaža

Bolja optička slika betona

- 12 zahvaljujući urednom rasteru fuga i sidara

Primjeri projekata

- 14 Optimalan sistem za svaki zahtjev

Pouzdan

- 16 zahvaljujući sistematičnoj tehnici zatvaranja

Standardna primjena

s unutarjnim kutnim elementom 50/20

- 20 Spojevi elemenata, T-zidovi, zidni priključci, kutovi, zidni pomaci

Standardne primjene

- 22 Čeone oplata, izjednačavanje dužine, kosi kutovi

Dopune sistema

- 24 Unutarnji kutni element 60/60
25 Tlačna i vlačna razupora

- 26 Pregled programa



MAXIMO

Okvirna oplata s MX sidrom za jednostrano rukovanje

Od uvođenja na tržište 1986. godine PERI TRIO razvio se u najuspješniju okvirnu oplatu širom svijeta. Mjerila su postavili argumenti kao primjerice malo različitih veličina elemenata ili samo jedna spojna komponenta, spojnica BFD.

Razvojem oplata MAXIMO PERI je opravdao ulogu tehnološkog lidera na tržištu.

Taj samostalni sistem oplata kompatibilan je s TRIO oplatom i ispunjava sve zahtjeve u pogledu ekonomičnosti i postignute izvedbene kvalitete.

Slika lijevo: savršene betonske površine u PERI podružnici Viersen, oblikovane MAXIMO oplatom.

PERI MAXIMO okvirna oplata

■ Brže

zahvaljujući jednostranom sidru s MX tehnikom sidrenja bez juvidur cijevi

■ Štedi vrijeme

zahvaljujući sistematiziranim i reduciranim sidrenim pozicijama

■ Bolja optička slika betona

zahvaljujući urednom rasteru fuga i sidara

Fleksibilan sistem okvirne oplata za svaki zahtjev

na malim gradilištima ...



MX sidro kojim se rukuje jednostrano čini MAXIMO izrazito ekonomičnim. Podrum obiteljske kuće Buchenberg/Vorderburg

... i na velikim gradilištima.



Uredna slika fuga i sidara dopušta betonske površine visoke kvalitete. Garaža Albanstraße, Mainz

Brže

zahvaljujući MX sidru kojim se rukuje jednostrano



MX sidro 20 - 30
br. art. 112387
za debljine zida 20/22/24/25/30

Konično formirano MX sidro ubetonira se prilikom punjenja oplata. Zbog svog specijalnog oblika koristi se bez juvidur cijevi i konusa. To štedi materijal, a sidra se znatno brže montiraju i demontiraju!

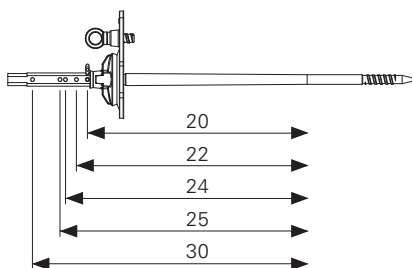

MX sidro 15 - 25
br. art. 113847
za debljine zida 15/17,5/20/22/24/25

MX sidro 30 - 40
br. art. 112464
za debljine zida 30/35/36/40

Slijed montaže MX sidra

Priprema

A. Prva oplata



Pozicionirati MX zglobnu maticu, fiksirati prstenasti vijak i čvrsto okretati ključem za MX sidra.

B. Sidro



Potrebnu debljinu zida označiti opružnim osiguračem te maticu okretati suprotno od opružnog osigurača.

Montaža sidra

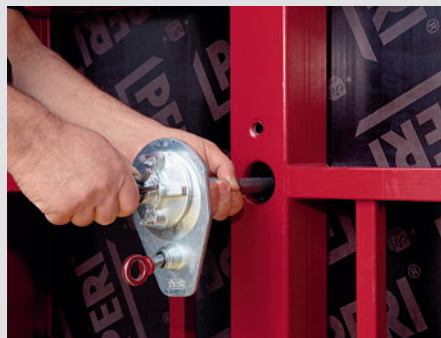

1. Kroz oplatu za zatvaranje sidro provući u zglobnu maticu i zakrenuti.



2. MX sidro zakretati MX sidrenim ključem-2 dok prstenasti vijak ne nalegne.

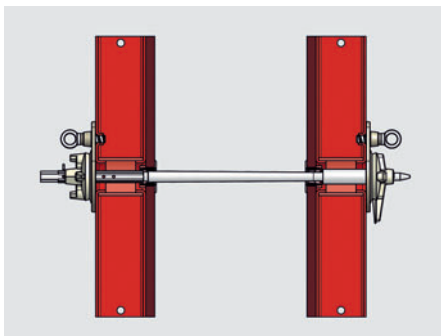

Otvor u okviru dopušta kutno odstupanje sidra od $\pm 4^\circ$.

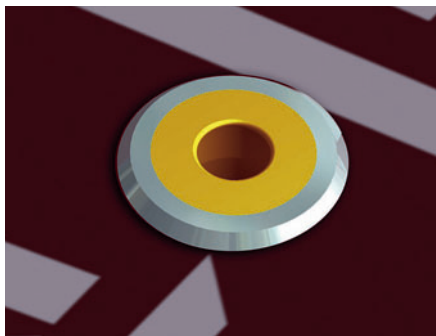

Sidreni otvor je metalnim prstenom zaštićen od udaraca. Brtvena čahura zatvara sidrenu poziciju i sprečava curenje betona.

Kod PERI MAXIMO oplata osim MX tehnike sidrenja mogu se koristiti i uobičajeni sistemi DW 15 ili DW 20.

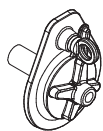

MX zglobna matica
br. art. 112386

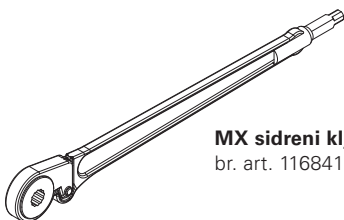

MX sidreni ključ-2
br. art. 116841



3. MX sidro stezati MX sidrenim ključem-2 dok ne nalegne.



4. Stezati prstenasti vijak.

Demontaža sidra

1. Osloboditi prstenasti vijak i izvući ga.
2. Sidro izvući MX sidrenim ključem-2.

Štedi vrijeme sistematiziranim sidrenim pozicijama

Kod MAXIMO oplata sidrene pozicije su sistematizirane, tj. kod svih veličina elemenata raspoređene su u sredini i popunjene.



Sidrena pozicija MAXIMO.

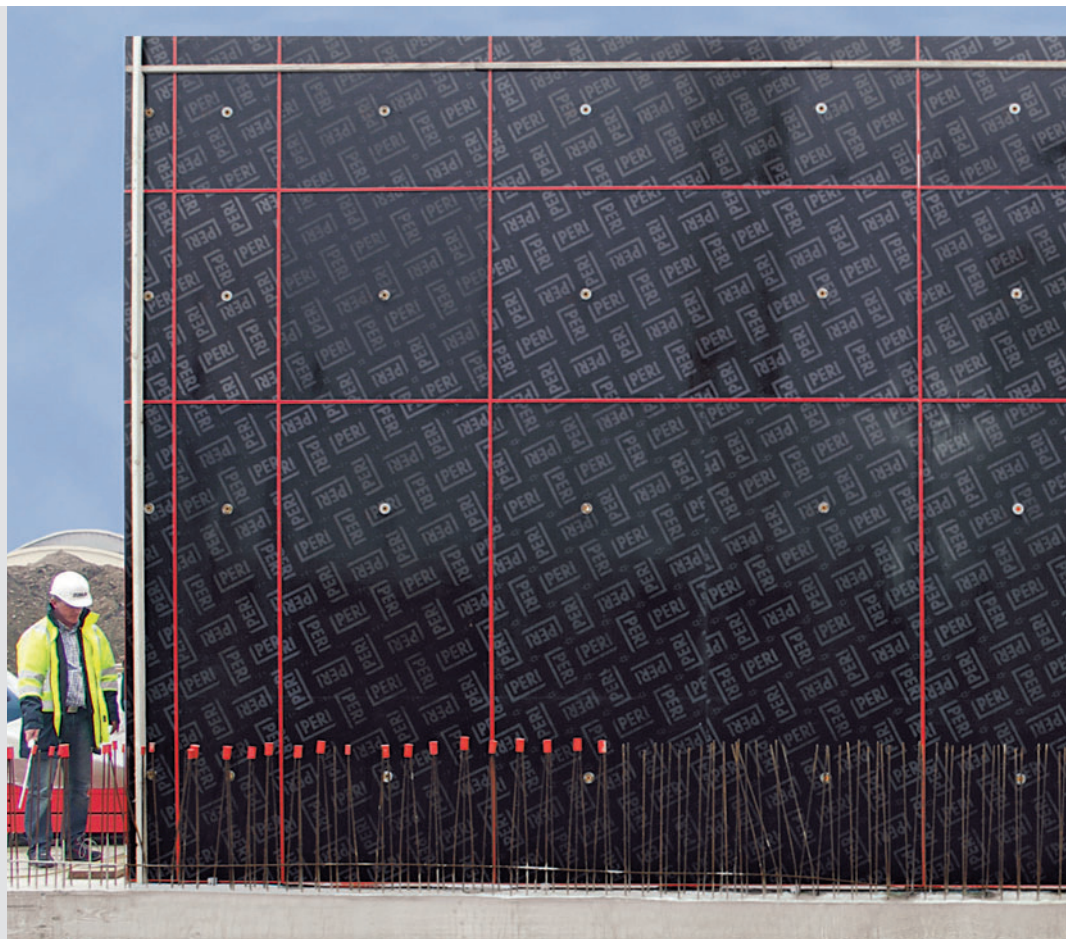

**MAXIMO ne zahtijeva rubna sidra,
sve sidrene pozicije su popunjene.**

**Kod uobičajenih okvirnih oplata
nepopunjene sidrene pozicije moraju
se zatvoriti.**

Često su upravo zbog nezatvorenih
sidrenih otvora potrebni dodatni radovi:

- oslobađanje zabetoniranih sidrenih pozicija u elementu
- kozmetika betona na površinama na kojima je beton iscurio.

		širina					
		240	120	90	60	45	30
visina	30						
	60						
	90						
	120						
	270						
	330						

Raster elemenata 30 cm

MAXIMO elementi raspoloživi su u 6 visina od 30 cm do 3,30 m te u 5 širina od 30 cm do 2,40 m u rasteru od 30 cm. Na raspolaganju je dodatno i element širine 45 cm koji značajno reducira uporabu prilagodnih ploča.

Spojevi elemenata pomoću spojnice BFD

Spojница BFD osigurava uredne spojeve elemenata, a time i uredne betonske površine.

Zahvaljujući samo jednoj komponenti svaki spoj je povezan, ravan i čvrst.

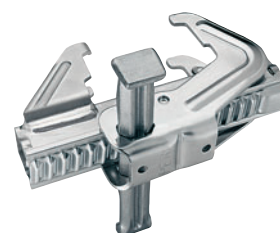

Štedi vrijeme reduciranim sidrenim pozicijama

Uobičajena oplata

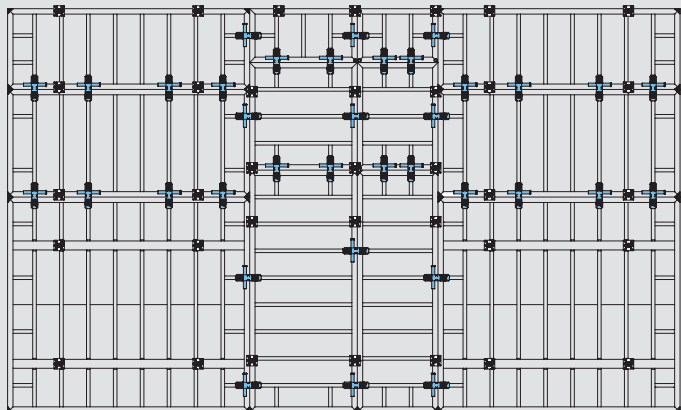

PERI MAXIMO

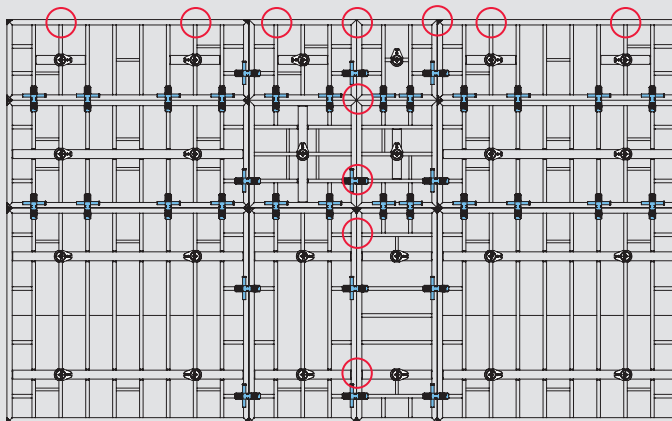

○ ušteda na sidrenim pozicijama

Usporedba PERI MAXIMO oplata i uobičajene okvirne oplata

Osim vremenske prednosti zahvaljujući MX sidru za jednostrano rukovanje na troškove pozitivno utječe i reducirani broj sidrenih pozicija.

MAXIMO

- i do 40% manje sidara
- jasan raster elemenata
- uredna optička slika sidara i fuga



Zahvaljujući njihovom centričnom rasporedu potrebno je i do 40% manje sidara.

Unatoč smanjenom broju potrebnih sidara s oplatom MAXIMO brzo se betonira.

Visoki dopušteni pritisak svježeg betona

Dopušteni pritisak svježeg betona za elemente 2,70 m prema DIN 18218.

81 kN/m² velikoplošnog opterećenja

DIN 18202, tab. 3, red 6.

67,5 kN/m² trokutnog opterećenja

DIN 18202, tab. 3, red 7.

MAXIMO ispunjava visoke zahtjeve u pogledu ravnosti.

Velika čvrstoća elemenata osigurava male progibe, minimalne deformacije te visoki stupanj ravnosti betonskih površina.

Štedi vrijeme

smanjenom potrebom za radnim osobljem

Za izradu betonskih zidova pomoću okvirne oplata dva nasuprotno postavljena elementa oplata moraju se sidriti.

MX sidro

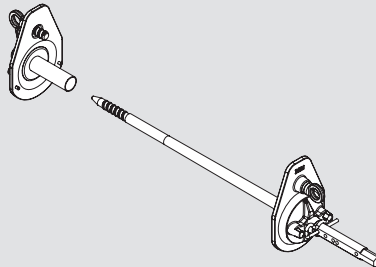

MAXIMO

Kod inovativnog sidrenja MAXIMO elemenata okvirne oplata sidrom se uvijek rukuje s jedne strane, nakon jednokratne montaže zglobne matice na prvu oplatu. Time se štedi na radnoj snazi - troškovi se smanjuju za oko 40%.

DW 15 sidro

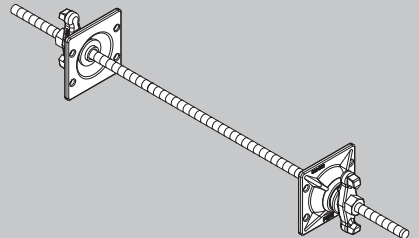

Uobičajena oplata

Kod uobičajenih sistema oplata u ovoj radnoj fazi je na svakoj strani oplata potreban po jedan radnik.

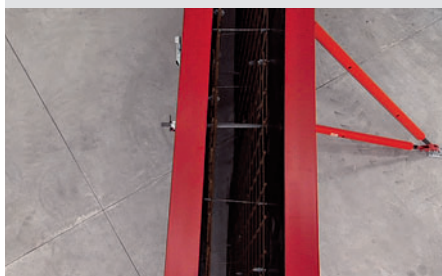
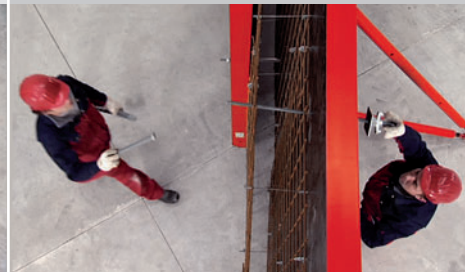
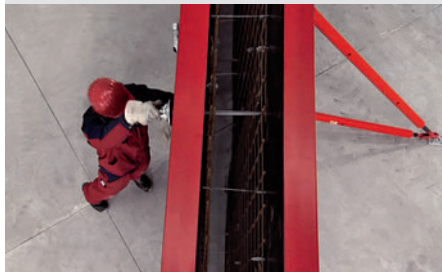

Ostale informacije za usporedbu nači čete na stranici:

www.peri.com.hr/maximo



Štedi se na radnim skelama

Zahvaljujući jednostranom rukovanju sidrom može se uštedjeti na dodatnim sigurnosnim uređajima, npr. na radnim skelama na prvoj oplati, što je od osobitog značenja kod visokih oplata.

Manje radnih faza = brža montaža

Usporedba

Uobičajena okvirna oplata u odnosu na MAXIMO

Montaža - armiranje - betoniranje		uobičajena oplata	MAXIMO
1	Mjerenje / označavanje na temeljnoj ploči	+	+
2	Montirati prvu oplatu	+	+
3	MX zglobnu maticu premazati voskom i montirati je		+
4	Prvu oplatu premazati uljem	+	+
5	Postaviti prvu oplatu / tiplama učvrstiti kosnike	+	+
6	Montirati osiguranje od pada (međupoložaj za rukovanjem sidrom na visinama iznad 3,00 m)	++	
7	Postaviti skelu za betoniranje	+	+
8	Izmjeriti / obilježiti otvore	+	+
9	Sanduke otvora učvrstiti čavlima	+	+
10	Zatvoriti nepopunjene sidrene otvore	+	
11	Matičnu ploču zavrnuti na sidro	+	
12	Umetnuti sidro	+	
13	Juvidur cijevi izrezati po mjeri	+	
14	Konuse nataknuti na juvidur cijev s obje strane	+	
15	Juvidur cijevi pomjeriti na sidro	+	
16	Armirati	+	+
17	Skinuti armaturnu skelu	+	+
18	MX sidro podesiti prema debljini zida (jednokratno prema zadanoj debljini zida)		+
19	Montirati oplatu za zatvaranje	+	+
20	Oplatu za zatvaranje premazati uljem	+	+
21	Montirati osiguranje od pada	+	+
22	Postaviti oplatu za zatvaranje	+	+
23	MX sidro premazati uljem		+
24	Zavrnuti MX sidro (1 djelatnik)		+
25	Učvrstiti prstenasti vijak		+
26	Matičnu ploču zavrnuti na sidro (2 djelatnika)	++	
27	U nekim slučajevima izvaditi čepove zbog krivo popunjenih sidrenih pozicija (2 djelatnika)	++	
28	Sastaviti čeonu oplatu	+	+
29	Betonaža	+	+
Demontaža			
30	Osloboditi matičnu ploču (2 djelatnika)	++	
31	Demontirati sidro (2 djelatnika)	++	
32	Osloboditi prstenasti vijak (1 djelatnik)		+
33	Demontirati MX sidro (1 djelatnik)		+
34	Demontirati i odložiti oplatu za zatvaranje	+	+
35	Očistiti oplatu za zatvaranje	+	+
36	Demontirati prvu oplatu i ponovo je staviti sprijeda (u idealnom slučaju)	+	+
37	Očistiti prvu oplatu	+	+
38	Skinuti tlačne konuse	+	
39	U danom slučaju kozmetika otisaka na betonu od nezatvorenih sidrenih otvora	+	
40	U danom slučaju bušenje sidrenih otvora u oplati po izboru	+	
Ostalo			
	I do 25% više sidara kod uobičajene oplate, prije svega kod visokih oplata	++	
	U uskim unutarnjim oplatama okna kod uobičajenih sidara potreban je i drugi djelatnik.	++	

Bolja optička slika betona zahvaljujući urednom rasteru fuga i sidara



Oblikovanje betonskih površina Sistematično, ekonomično, jednostavno

Učinkovitim sistemom okvirne oplata realizirati specijalne zidne površine bez velikih troškova i rada, često je želja investitora i arhitekata. PERI MAXIMO je okvirna oplata sa centrično raspoređenim sidrenim pozicijama kod svakog elementa.

Rezultat je pravilna slika fuga - i horizontalno i vertikalno.

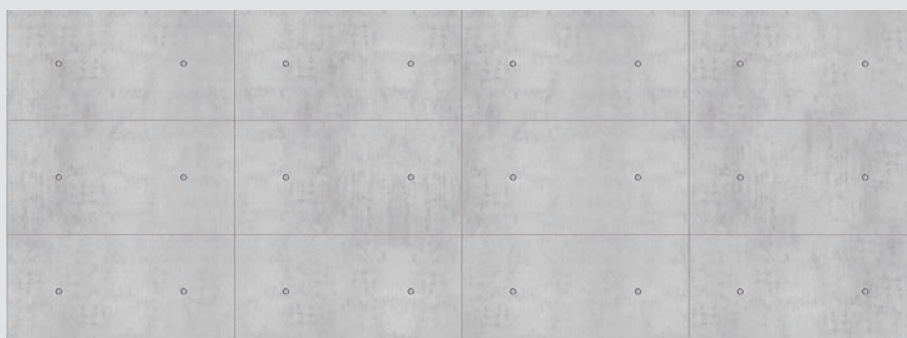

Oblikovanje betonskih površina MX rasterima

Mogućnost odabira različitih kombinacija elemenata otvara fleksibilan oblikovni prostor - ekonomično realiziran pomoću PERI MAXIMO oplata.

Primjer: MX raster "naslaga".
Više pod: www.peri.com.hr/maximo

Definiran raspored pojedinačnih MAXIMO elemenata u takozvanom "MX rasteru" omogućuje optički ugodno oblikovanje betonskih površina.

- uredna optička slika betona
- bez otisaka nepopunjenih sidrenih pozicija
- bez curenja betona na nezatvorenim sidrenim pozicijama



Savrešeno oblikovane betonske površine pomoću PERI MAXIMO oplate.

Primjeri projekata

Optimalan sistem za svaki zahtjev



Uređeni raster fuga i sidara na vidnim zidnim površinama.
Poslovna zgrada Outlet-Center,
Metzingen



Kratko vrijeme gradnje uz manje radnog osoblja.
Podrum dvojnog stambenog objekta,
Rosenheim



Osim zahtjeva za fleksibilnom, a istovremeno učinkovitom primjenom kod izvedbe različitih građevinskih komponenti, MAXIMO zahvaljujući vještom odabiru i rasporedu elemenata ispunjava i zahtjev za oblikovanjem vidnih betonskih površina visoke kvalitete.

MAXIMO za visoke, kose zidove u kombinaciji sa SKS penjajućim konzolama.
Kongresni centar Am Schlossberg, Heidenheim

Proširenje postaje za ekološka istraživanja Schneefernerhaus, Zugspitze.



MAXIMO uporabljen za penjanje na preklopnom podestu FB 180. Logistički centar Siemens, Frankfurt



Visoke, vidne zidne površine. Rehabilitacijski centar Stuttgart-Fellbach



3-struko nadograđen, premješten kao kompletna jedinica s uštedom na radnoj skeli na suprotnoj strani. Scena za probe, Državno kazalište, Stuttgart

Pouzdan zahvaljujući sistematičnoj tehnici zatvaranja

Kod MX sidra

Sidrenje

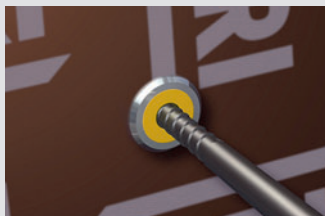

MX sidro
ovisno o debljini zida
(vidi stranicu 4)

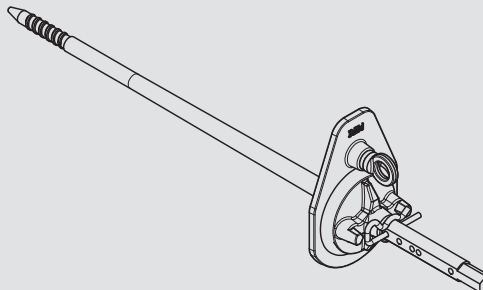

Sistem zatvaranja

Čepovi
MX Ø 17,5 - 22
br. art. 114300

- velike lamele
- za sve promjere otvora
17,5 - 22 mm



Vijčani čepovi
MX 50 OF
br. art. 114503

- dublja ugradnja
- za sve promjere otvora
17,5 - 22 mm*

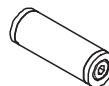

Zahtjevi

- samo optičko zatvaranje
- izolacija od vode koja nije pod tlakom
- zidovi s funkcijom zvučne zaštite*
- zidovi s klasom vatrootpornosti F90*

*postoje ispitni izvještaji

Sidrena pozicija zatvorena



Montaža

Ugrađuje se u sekundi 6-bridnim natičnim ključem ili još brže uz pomoć akumulatorskog odvijača - neovisno o utjecajima okoliša (npr. temperaturi) i tehnici betona.

6-bridni natični ključ 4 mm

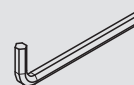

**Vijčani čepovi
MX 50 MF**

br. art. 114496

- površinski kompaktna ugradnja

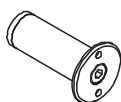

**Vijčani čepovi
MX 84 MF**

br. art. 114509

- površinski kompaktna ugradnja

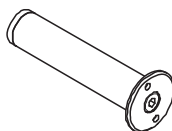

- izolacija od vode koja nije pod tlakom
- zidovi s funkcijom zvučne zaštite*
- zidovi s klasom vatrootpornosti F90*

*postoje ispitni izvještaji

- izolacija od vode koja nije pod tlakom prema DIN EN 206-1/ za građevinske elemente s velikim otporom na prodiranje vode*
- zidovi s funkcijom zvučne zaštite*
- zidovi s klasom vatrootpornosti F90*

*postoje ispitni izvještaji



Ugrađuje se u sekundi 6-bridnim natičnim ključem ili još brže uz pomoć akumulatorskog odvijača - neovisno o utjecajima okoliša (npr. temperaturi) i tehnici betona.

Čepni ključ MAXIMO
br. art. 114619
Za držanje vijčanih čepova.

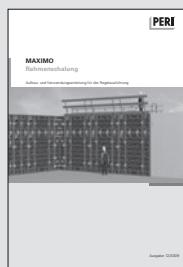
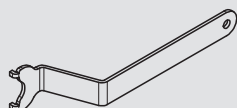

Voditi računa o PERI uputama za primjenu i montažu!

Pouzdan zahvaljujući sistematičnoj tehnici zatvaranja

Kod MX sidra i brtvenog konusa MX 55

Sidrenje



Magneti ugrađeni u konus sigurno ga fiksiraju na metalni prsten brtve ugrađene u element.

**Magnetni konus
MX 55**
br. art. 112937

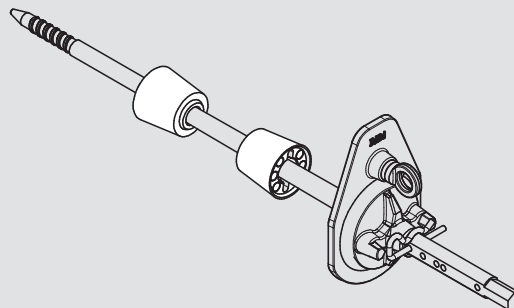

Sistem zatvaranja

DK betonski konus DW 15-58/30
br. art. 031642

**DK betonski konus pogled/01
DW 15-58/52**
br. art. 031641

**DK betonski konus
UNI 58/52**
br. art. 031643

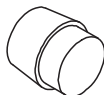

Zahtjevi

- primjena za optički zahtjevno oblikovanje vidnih betonskih površina
- s dubinskom ugradnjom

- primjena za optički zahtjevno oblikovanje vidnih betonskih površina
- s osjenčanom fugom

- protiv vode pod tlakom prema DIN EN 206-1/ za građevinske elemente s velikim otporom na prodiranje vode*, primjerice za uređaje za pročišćavanje ili za spremnike pitke vode kod kojih betonska površina i konus moraju biti kompaktni
- zidovi s funkcijom zvučne zaštite*
- zidovi s klasom vatrootpornosti F90*, npr. stubišta

*postoje ispitni izvještaji

Sidrena pozicija zatvorena

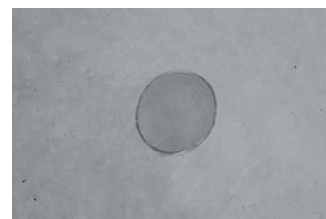
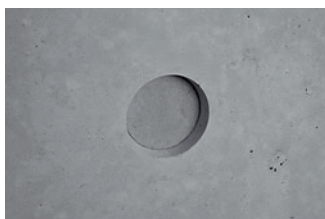

Montaža

Brtni konus demontira se uz pomoć MX ključa za magnetne konuse. Ugradnju betonskih konusa vidjeti u brošuri PERI tehnika sidrenja.

MX ključ za magnetne konuse
br. art. 114797

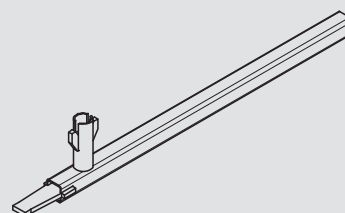

Kod sidra DW 15 i konusa MX DR 22

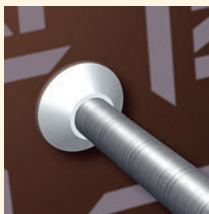

Primjena s juvidur cijevi, hrapavom DR 22 ili cijevi od vlaknastog cementa FZR. Pokriva brtvljenje na elementu.

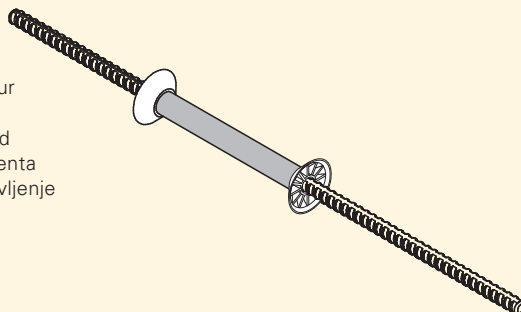

Konus MX DR 22
br. art. 113018

S DK brtvenim konusom DW 20/55 i sidrom DW 20

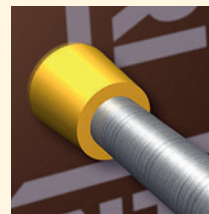

Primjena s juvidur cijevi DR 28 i DR betonskim konusom UNI 58/52.

DK brtveni konus DW 20/55
br. art. 031637

Čepovi DR 22
br. art. 065036

Čepovi FRZ 22
br. art. 031360

Adekvatno se mogu rabiti i DK brtveni konusi za DW 15.



ili



DK betonski konus UNI 58/52
br. art. 031643



■ samo optičko zatvaranje

- protiv vode pod tlakom prema DIN EN 206-1/ za građevinske elemente s velikim otporom na prodiranje vode*
- zidovi s klasom vatrootpornosti F90*, npr. stubišta

*postoje ispitni izvještaji

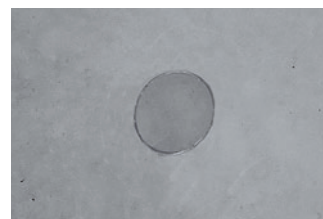

Standardna primjena s unutarnjim kutnim elementom 50/20

Spojevi elemenata, T-zidovi, zidni priključci

Spojevi elemenata

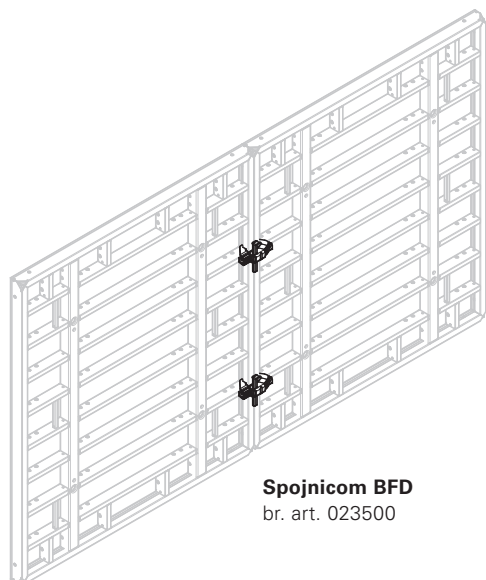

Spojnicom BFD
br. art. 023500

Zidni priključci

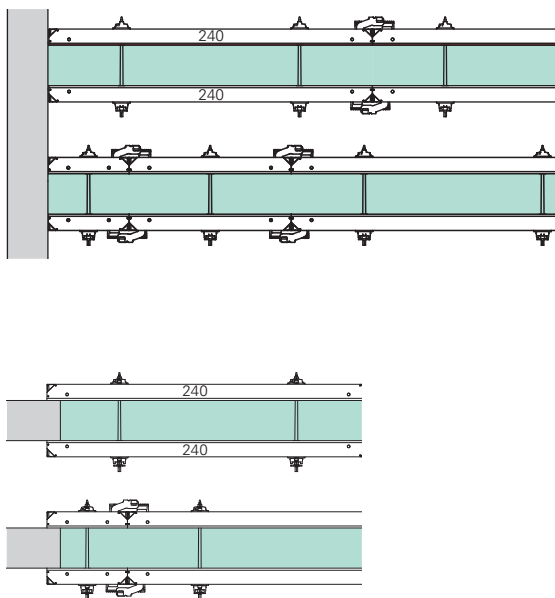

T-zidovi

Debljine zidova 15 - 40 cm

Unutarnja oplata

Unutarnji kutni element MXI 50/20
3 x spojnica BFD

Vanjska oplata

Element MX 60
2 x spojnica BFD

Prilagodba debljini zida elementom
za izjednačavanje debljine zida MX
ili rubnom gredicom.

3 x spojnica BFD

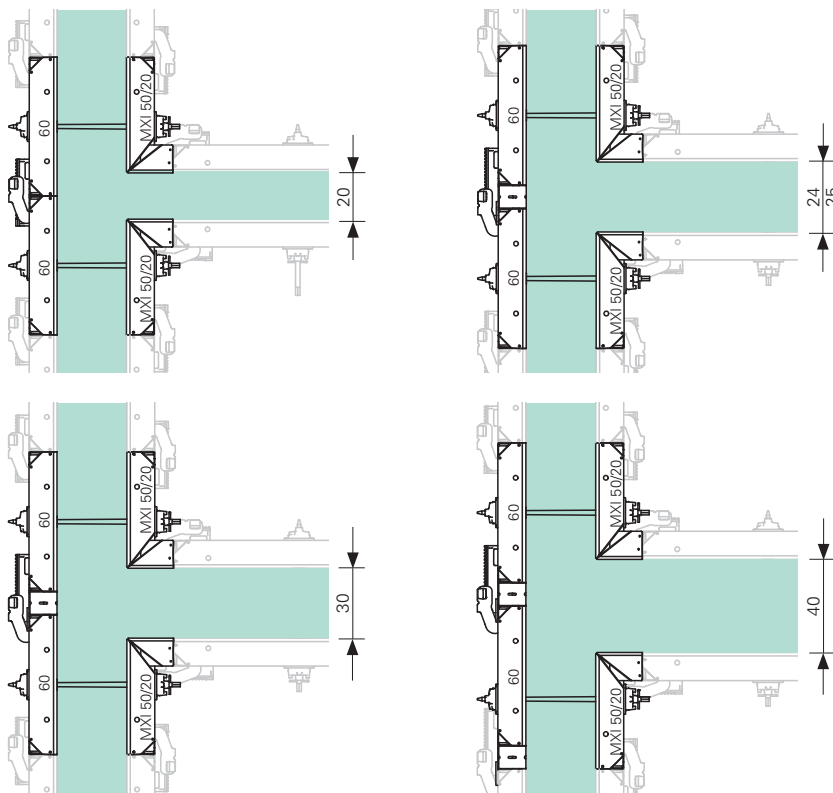

Kutovi, zidni pomaci

Kutovi s MXI 50/20

Debljine zidova 15 - 40 cm

Unutarnja oplata

Unutarnji kutni element MXI 50/20

3 x spojnica BFD

Vanjska oplata

Vanjski kutni element MXA 45

Element MX 30

4 x spojnica BFD

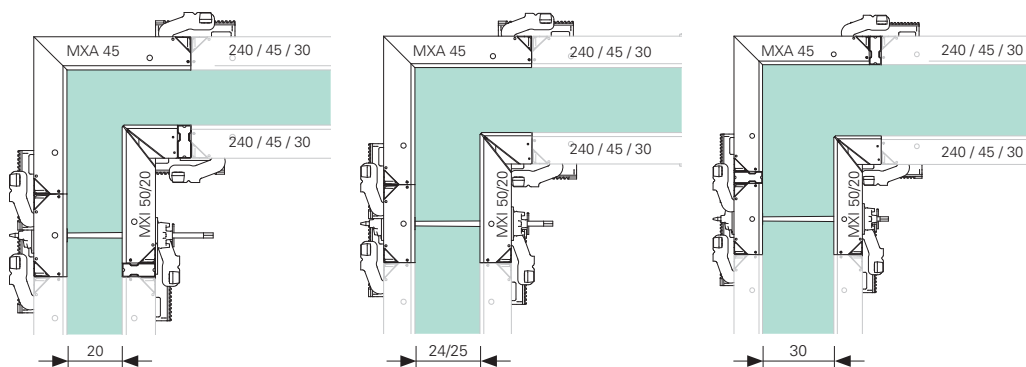
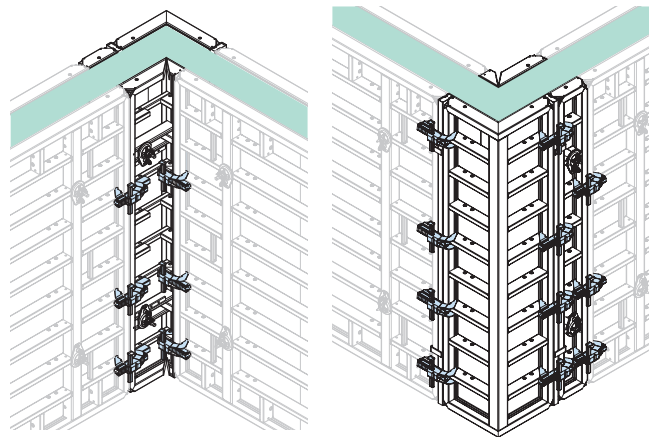

Na kratkom kraku unutarnjeg kutnog elementa MXI 50/20 nije potrebno sidro.

Zidni pomak

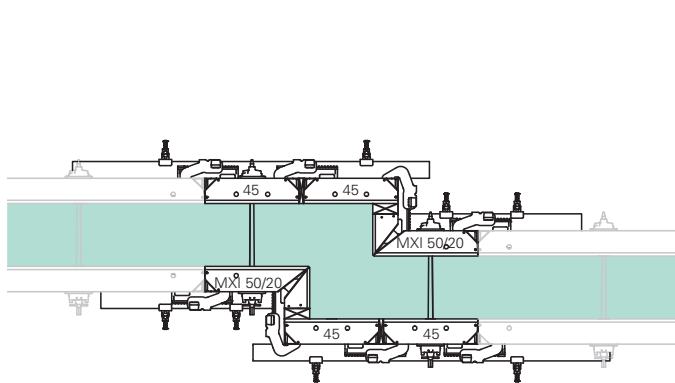

20 - 28 cm

- unutarnji kutni element MXI 50/20
- element MX 45
- profil za izjednačavanje MAR 170
- profil za izjednačavanje MAR 85
- gradilišna prilagodna gredica

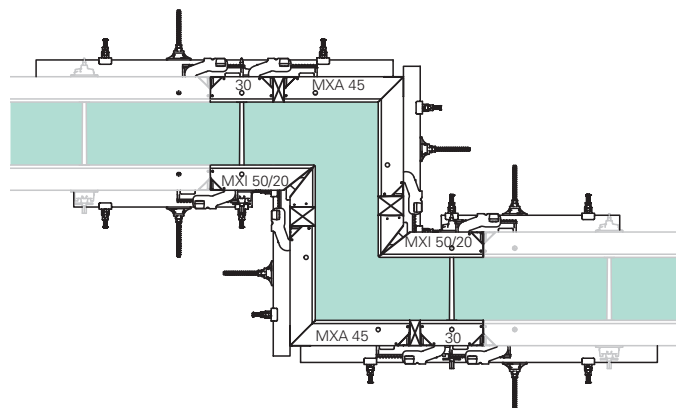

65 - 79 cm

- unutarnji kutni element MXI 50/20
- vanjski kutni element MXA 45
- element MX 30
- profil za izjednačavanje MAR 170 s 1 sidrenom kukom DW 15 i maticom sa zglobnom pločom
- profil za izjednačavanje MAR 85 s 1 sidrenom kukom DW 15 i maticom sa zglobnom pločom
- gradilišna prilagodna gredica

Standardne primjene

Čeone oplate

Čeone oplate

S konvencionalnim rješenjem

3 x profil za izjednačavanje MAR 85-2 na visini 2,70 m.

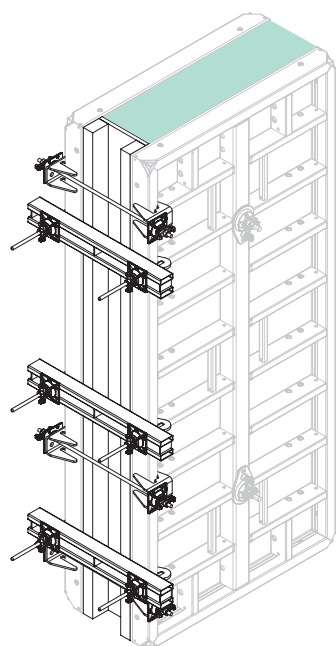

STRIO čeonim elementom MT/ MTF

Kod kontinuirane armature, s ili bez dilatacijske trake.

- ušteda vremena min. 40%
- bez oštećenja oplatne ploče

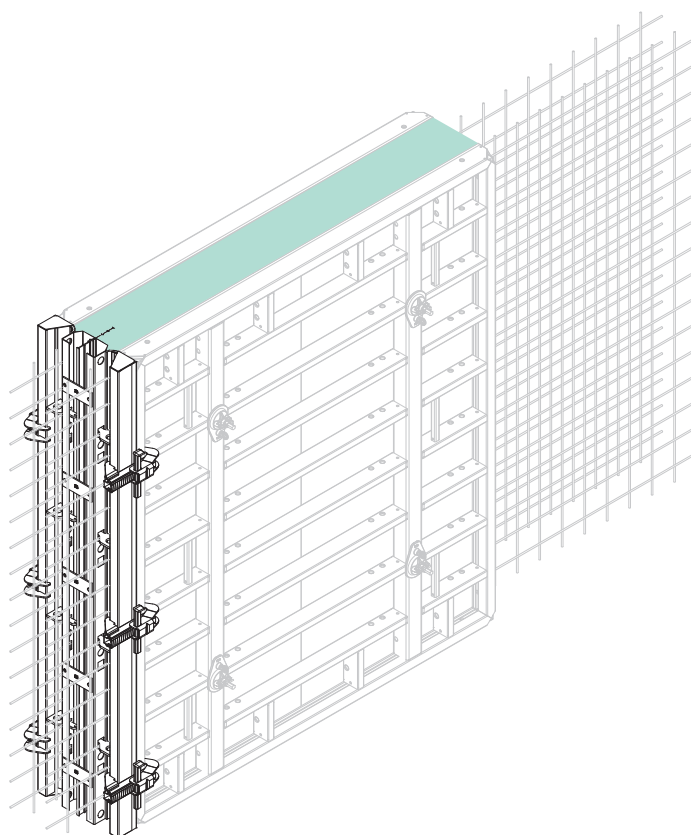

Srednji dio MT,
bez dilatacijske trake

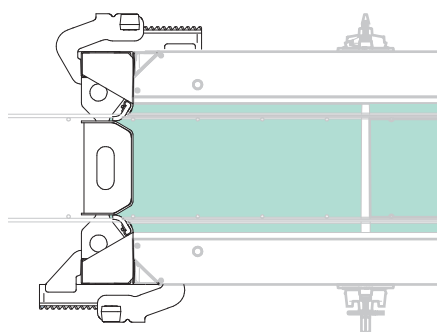

Srednji dio MTF,
s dilatacijskom trakom

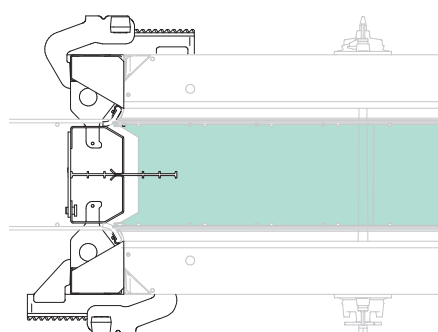

Izjednačavanja dužine, kosi kutovi

Izjednačavanja dužine

Do 10 cm

Elementom za izjednačavanje debljine zida MX ili rubnom gredicom i spojnicom BFD.

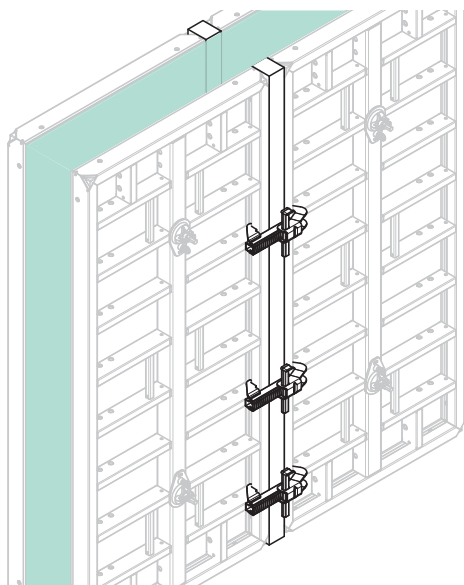

10 cm do 36 cm

Profilom prilagodne ploče TPP i oplatnom pločom.

TPP 270, br. art. 101813

TPP 120, br. art. 101823

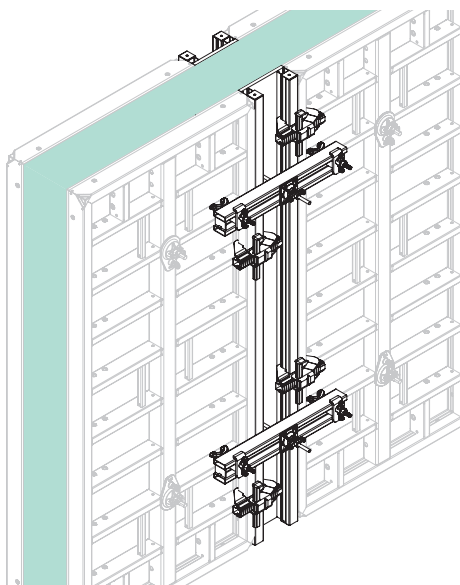

Kosi kutovi

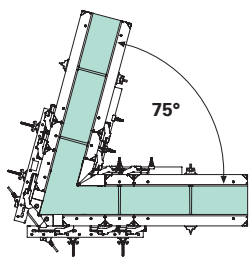

Izvana: 3 x BFD **2 4 7**
2 x SRU122 **1 6**

Iznutra: 2 x BFD **1 6**

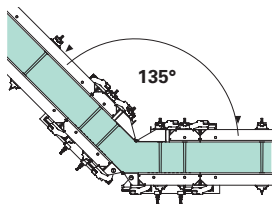

Izvana: 3 x BFD **3 5 8**
2 x MAR85 **1 6**

Iznutra: 2 x BFD **1 6**

Vanjska oplata

Zglobni kutni element MX, izvana
Element MXM 60
Element MX 45 i MX 30 kod 75°

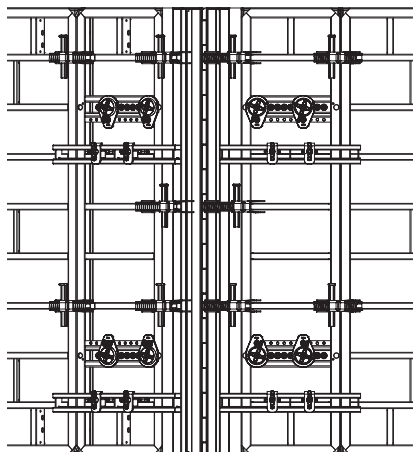

Unutarnja oplata

Zglobni kutni element MX, iznutra
Element MX 45
Element MX 30 kod 75°

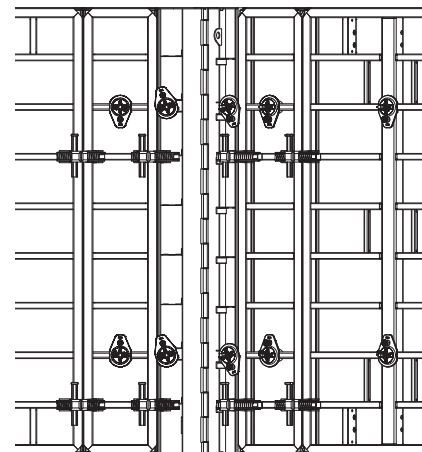

■ = broj profila

Sistemske dopune s unutarnjim kutnim elementom 60/60

Za oblikovane betonske površine te kod uporabe brtvenog konusa MX 55

Kutovi

Debljina zida 15 - 40 cm

Unutarnja oplata

- unutarnji kutni element MXI 60/60
- 3 x spojnica BFD

Vanjska oplata

- vanjski kutni element MXA 35 odn. 45
- 2 x element MX 45
- 4 x spojnica BFD

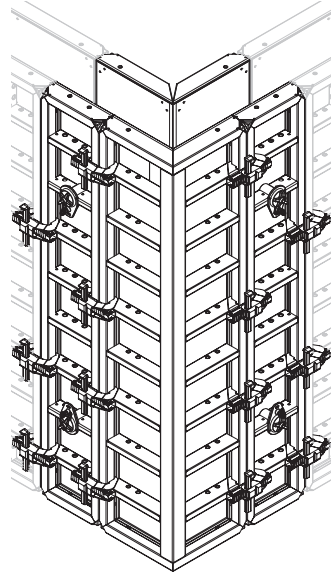
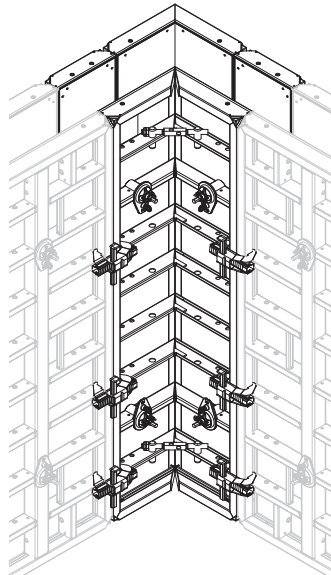
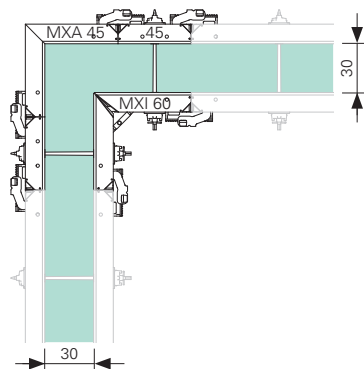

T-zidovi

Debljina zida 15 - 40 cm

Unutarnja oplata

- unutarnji kutni element MXI 60/60
- 3 x spojnica BFD

Vanjska oplata

- 2 x element MX 45
- 1 x element MX 60
- 3 x MAR 170-2
- 2 x spojnica BFD

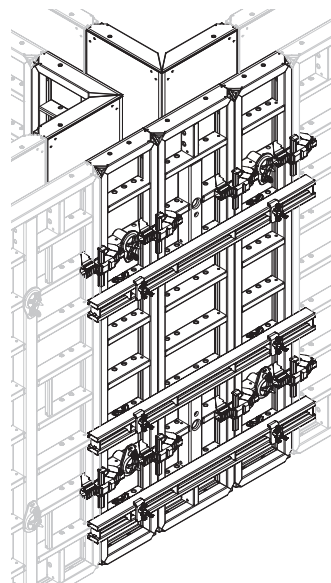
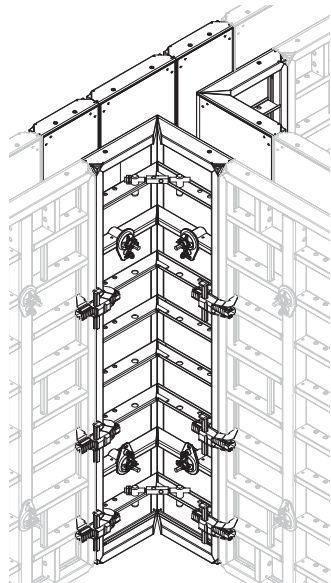
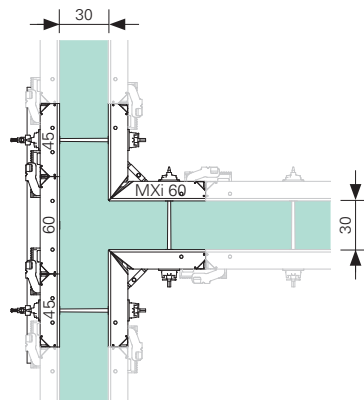

Tlačna i vlačna razupora

Centrična sidrena pozicija ima odlučujuće prednosti kod montaže temelja, konzola i greda.

Uporabom tlačne i vlačne razupore u spoju sa centričnim sidrom MAXIMO elementa nije potreban donji sidreni položaj.

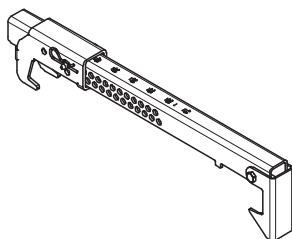

Tlačna i vlačna razupora MX
br. art. 115350



Temelj/označavanje bridova

- potreban minimalan radni prostor
- limovi fuga ne smetaju

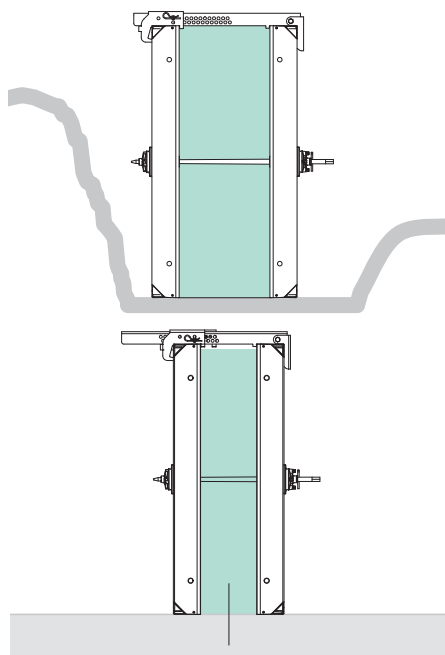

Konzole ili sl. građevinski elementi

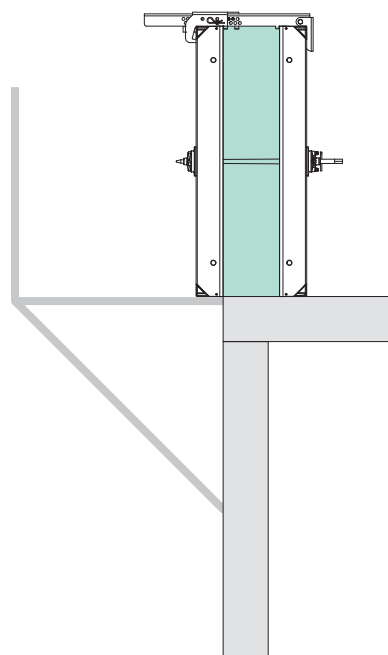

Greda

- jaka armatura ne smeta

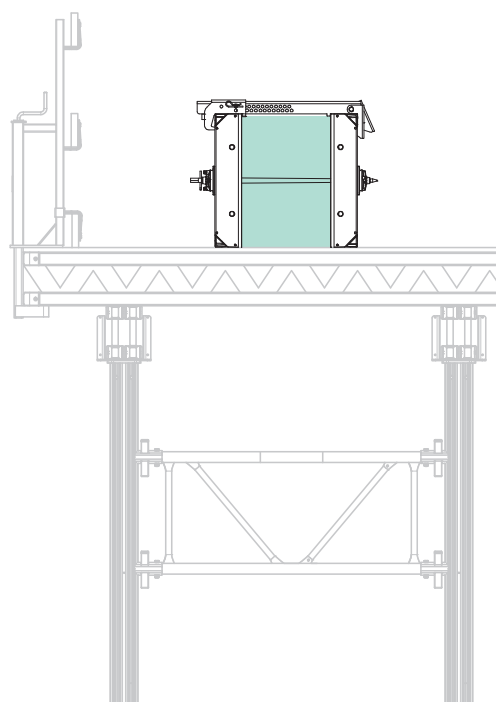

MAXIMO okvirna oplata



br. art.	težina kg
114426	408,000

Element MX 330 x 240

7,920 m². Element s oplatnom pločom 18 mm.

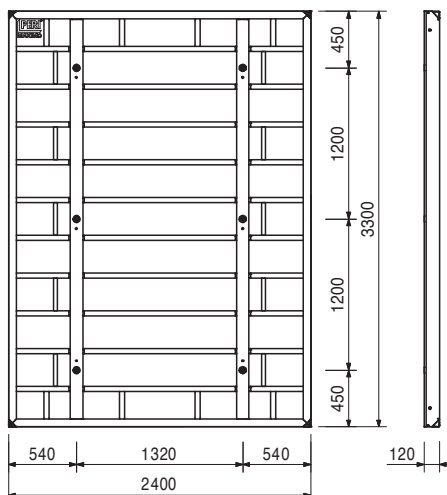
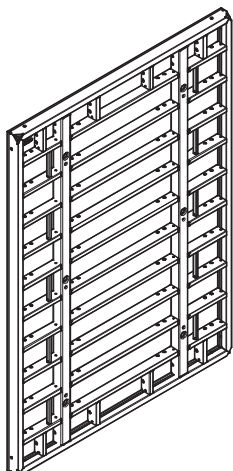

114248	226,000
--------	---------

Element MX 330 x 120

3,960 m². Element s oplatnom pločom 18 mm.

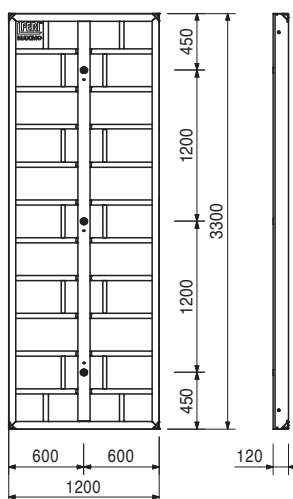
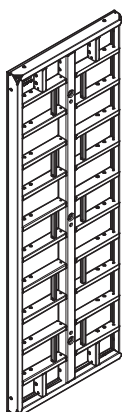

114258	172,000
--------	---------

Element MX 330 x 90

2,970 m². Element s oplatnom pločom 18 mm.

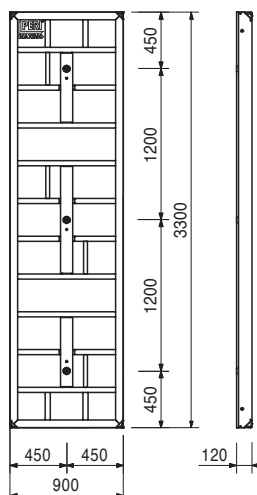
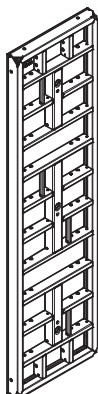

MAXIMO okvirna oplata

br. art.	težina kg
114445	118,000

Element MX 330 x 60

1,980 m². Element s oplatnom pločom 18 mm.

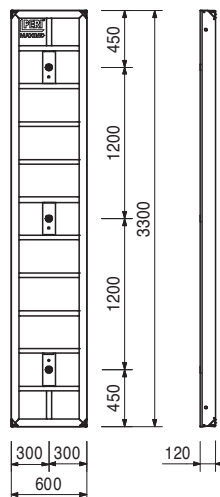

114452	99,800
--------	--------

Element MX 330 x 45

1,485 m². Element s oplatnom pločom 18 mm.

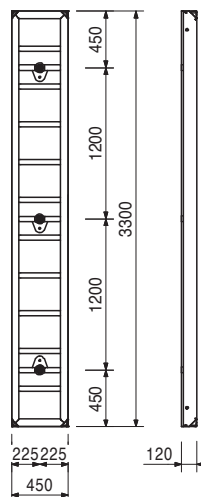

114457	79,600
--------	--------

Element MX 330 x 30

0,990 m². Element s oplatnom pločom 18 mm.

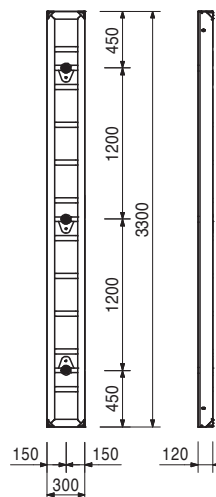

MAXIMO okvirna oplata



br. art.	težina kg
116454	445,000

Element MX 330 x 270

8,910 m². Element s oplatnom pločom 18 mm.

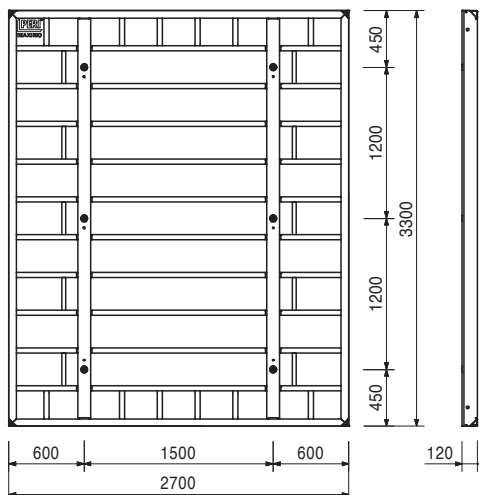
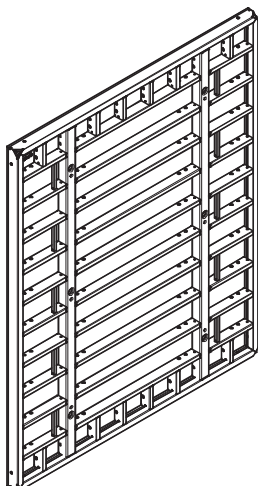

114464	133,000
--------	---------

Višenamjenski element MXM 330 x 60

1,980 m². Element s oplatnom pločom 18 mm.
Za kose kutove, zidne priključke itd.



Komplet s

33 kom. 116353 čepovi MXM Ø 21

33 kom. 113998 brtva MXM Ø 16

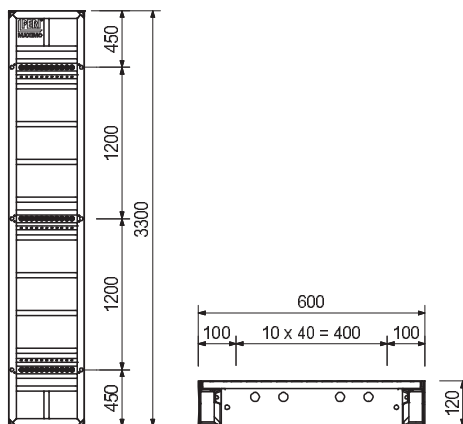

115338	135,000
--------	---------

Unutarnji kutni element MXI 330 x 50/20

2,310 m². Element s oplatnom pločom 18 mm.
Za unutarnji kutove od 90°.



Komplet s

12 kom. 116353 čepovi MXM Ø 21

12 kom. 113998 brtva MXM Ø 16

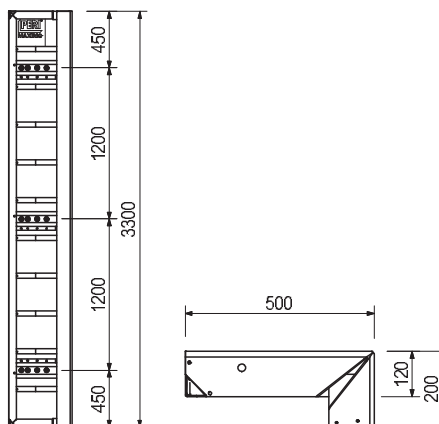

br. art.	težina kg
114470	206,000

Unutarnji kutni element MXI 330 x 60
 3,960 m². Element s oplatnom pločom 18 mm.
 Za unutarnje kutove od 90°.

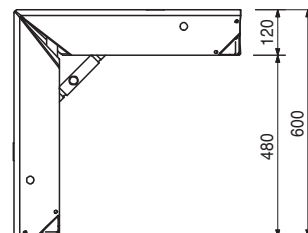
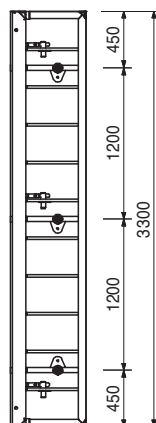
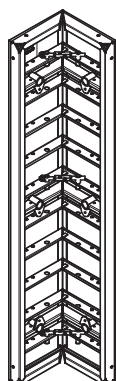

117913	380,850
--------	---------

Kutni element okna MXE 330
 Za unutarnje kutne elemente 90° te za demontažu i premještanje kompletne unutarnje oplata okna.

Sigurnosna uputa
 Nosivost točke preuzimanja opterećenja 2,0 t.

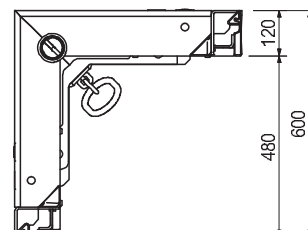
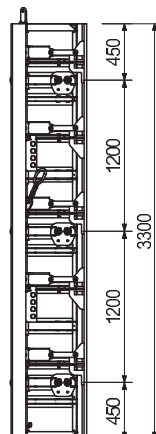
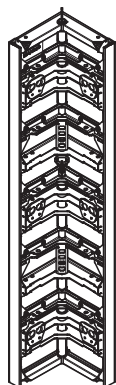

114478	175,000
--------	---------

Vanjski kutni element MXA 330 x 45
 2,970 m². Element s oplatnom pločom 18 mm.
 Za vanjske kutove 90°.

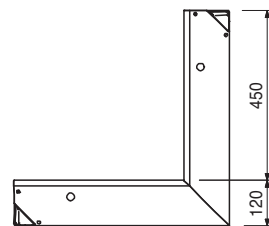
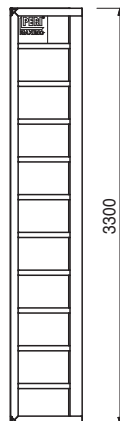
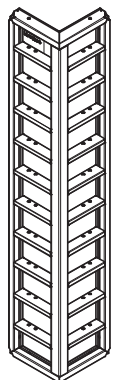

br. art.	težina kg
114486	154,000

Vanjski kutni element MXA 330 x 35

2,310 m². Element s oplatnom pločom 18 mm.
Za vanjski kut 90°.

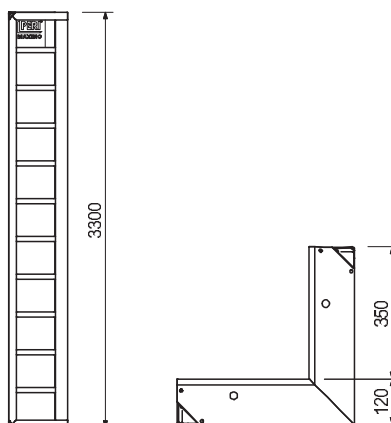
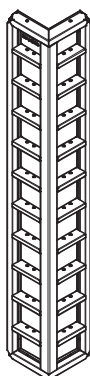

114583	86,600
--------	--------

Zglobni kutni element MXGI 330

1,980 m². Od aluminija.
Za kose kutove od 75° iznutra.

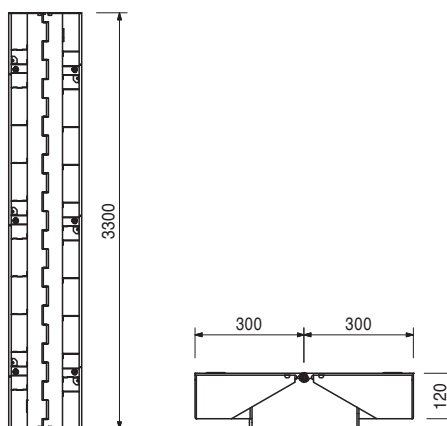

114607	51,100
--------	--------

Zglobni kutni element MXGA 330

0,990m² Od aluminija.
Za kose kutove od 75° izvana.

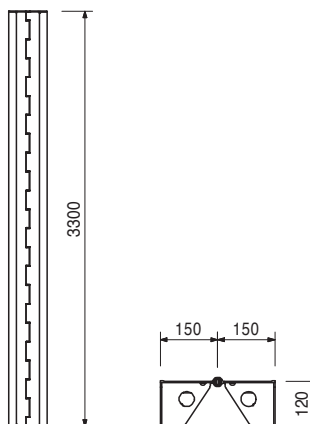

br. art.	težina kg		B
114842	17,800	El. za izjednačavanje debljine zida WDA MX 330	40
114826	18,900	El. za izjednač. debljine zida WDA MX 330 x 4	50
114846	20,200	El. za izjednač. debljine zida WDA MX 330 x 5	60
114394	12,100	El. za izjedn. deblj. zida WDA MX 330 x 10, Alu	

Za prilagodbu debljinama zida.

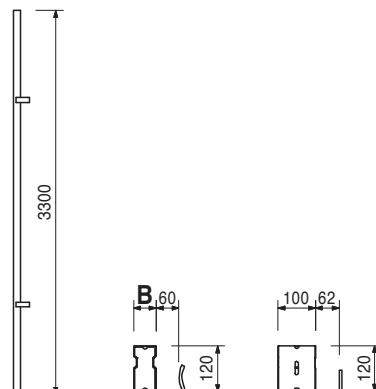

101829	9,790	Profil prilagodne ploče TPP 330, Alu Za izjednačavanje prilagodnom pločom 21 mm.
--------	-------	--

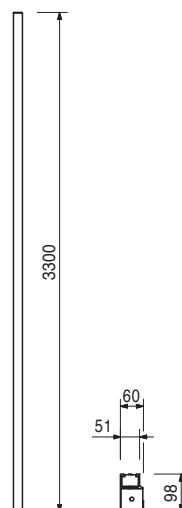

112006	336,000	Element MX 270 x 240 6,480 m ² . Element s oplatnom pločom 18 mm.
--------	---------	--

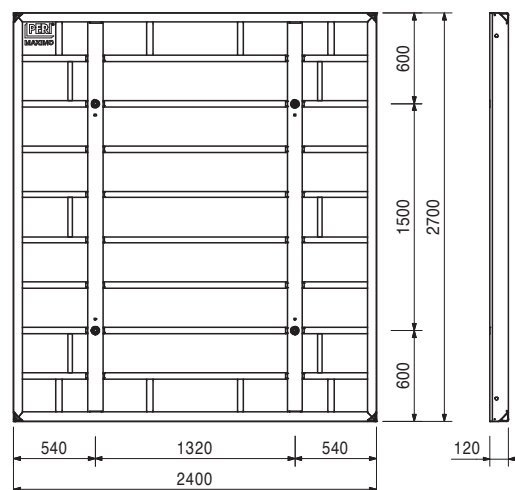
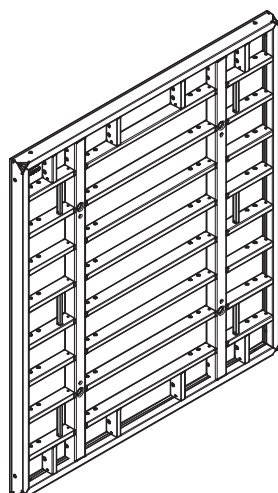

br. art.	težina kg
112022	186,000

Element MX 270 x 120

3,240 m². Element s oplatnom pločom 18 mm.

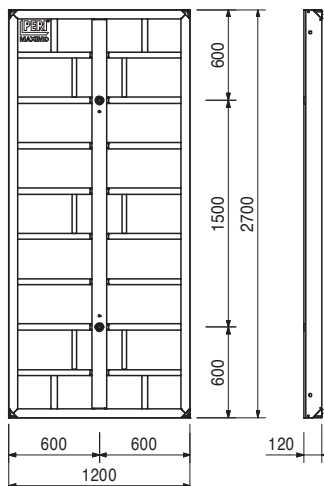
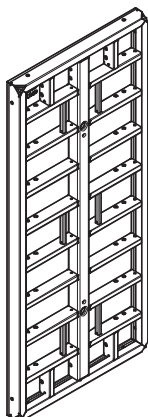

112045	135,000
--------	---------

Element MX 270 x 90

2,430 m². Element s oplatnom pločom 18 mm.

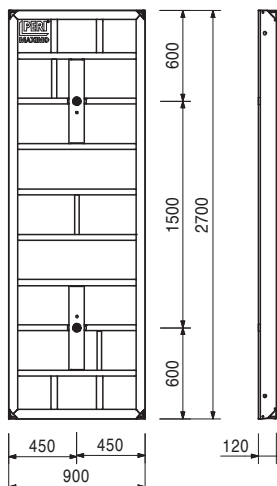
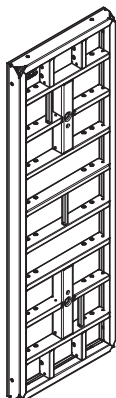

112200	104,000
--------	---------

Element MX 270 x 60

1,620 m². Element s oplatnom pločom 18 mm.

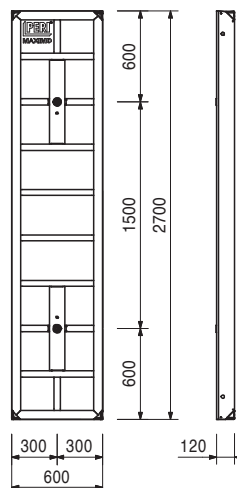

br. art.	težina kg
112078	77,600

Element MX 270 x 45

1,215 m². Element s oplatnom pločom 18 mm.

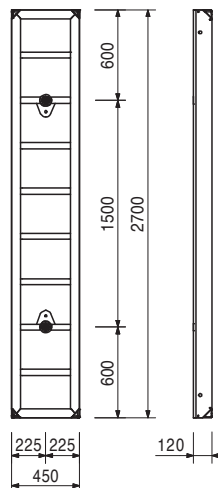

112090	62,800
--------	--------

Element MX 270 x 30

0,810 m². Element s oplatnom pločom 18 mm.

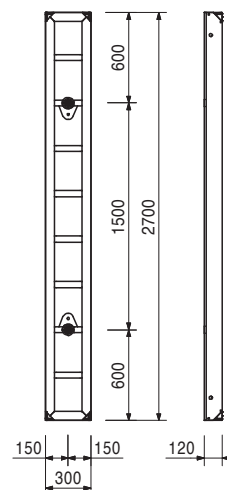

112849	101,000
--------	---------

Višenamjenski element MXM 270 x 60

1,620 m². Element s oplatnom pločom 18 mm.
Za kose kutove, zidne priključke itd.

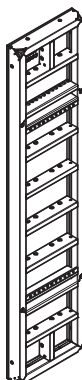

Komplet s

22 kom. 116353 čepovi MXM Ø 21

22 kom. 113998 čepovi MXM Ø 16

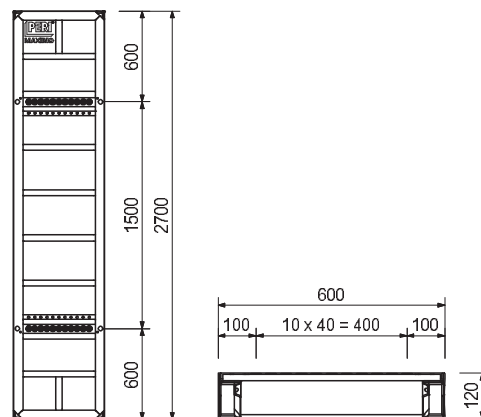

br. art.	težina kg
115255	102,000

Unutarnji kutni element MXI 270 x 50/20
 1,890 m². Element s oplatnom pločom 18 mm.
 Za unutarnje kutove od 90°.

Komplet s
 8 kom. 116353 čepovi MXM Ø 21
 8 kom. 113998 brtve MXM Ø 16

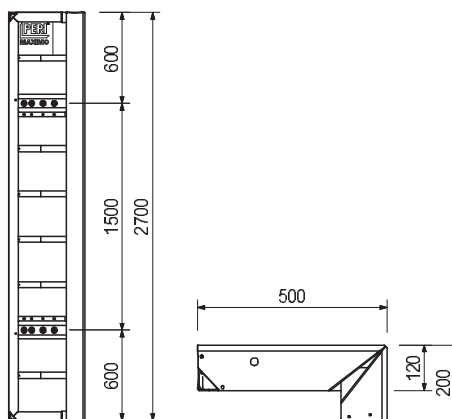

112419	156,000
--------	---------

Unutarnji kutni element MXI 270 x 60
 3,240 m². Element s oplatnom pločom 18 mm.
 Za unutarnje kutove od 90°.

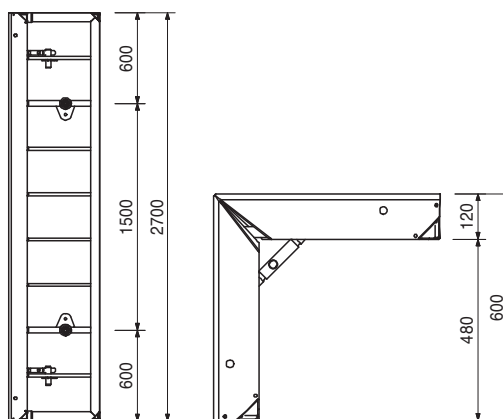
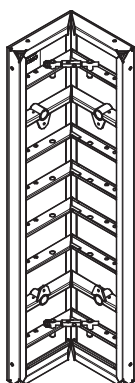

117914	286,010
--------	---------

Kutni element okna MXE 270
 Element za montažu unutarnjih kutova od 90° te
 za demontažu i premještanje kompletne unutarnje
 oplata okna.

Sigurnosna uputa
 Nosivost točke preuzimanja opterećenja 2,0 t.

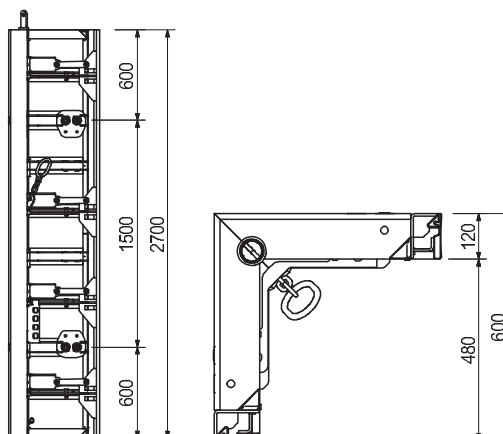

br. art.	težina kg
112887	294,000

Vanjski kutni element MXA 270 x 90
 4,860 m². Element s oplatnom pločom 18 mm.
 Za vanjske kutove 90°.

Komplet s
 24 kom. 116353 čepovi MXM Ø 21
 24 kom. 113998 brtve MXM Ø 16

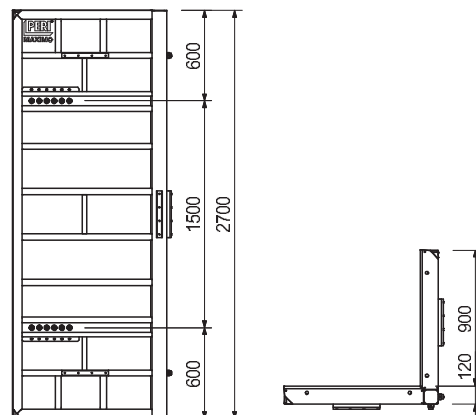
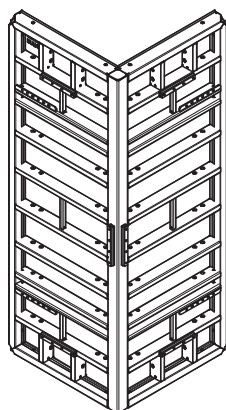

112806	145,000
--------	---------

Vanjski kutni element MXA 270 x 45
 2,430 m². Element s oplatnom pločom 18 mm.
 Za vanjske kutove 90°.

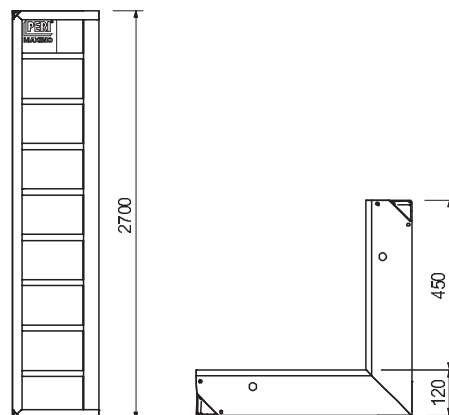
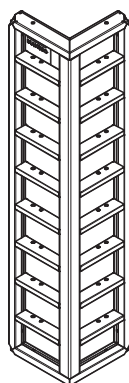

112667	127,000
--------	---------

Vanjski kutni element MXA 270 x 35
 1,890 m². Element s oplatnom pločom 18 mm.
 Za vanjske kutove 90°.

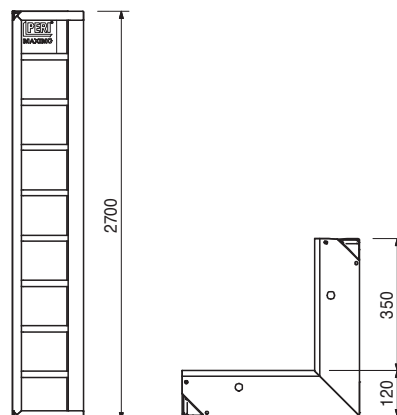
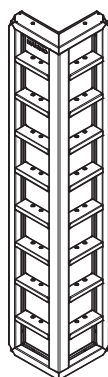

br. art.	težina kg
113203	69,400

Zglobni kutni element MXGI 270

1,620 m². Od aluminija.
Za kose kutove od 75° iznutra.

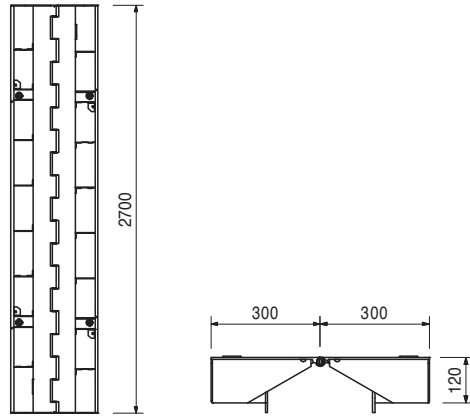
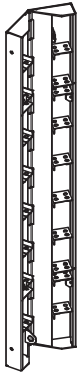

111872	41,800
--------	--------

Zglobni kutni element MXGA 270

0,810 m². Od aluminija.
Za kose kutove od 75° izvana.

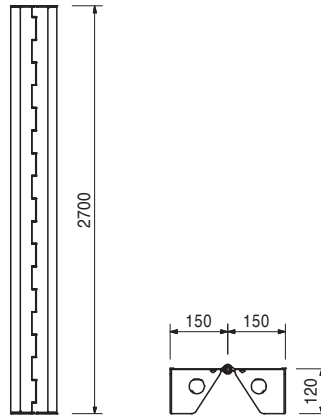

114165	14,700
114186	15,700
114174	16,800
114128	10,000

El. za izjednačavanje debljine zida WDA MX 270

El. za izjednač. debljine zida WDA MX 270 x 4
El. za izjednač. debljine zida WDA MX 270 x 5
El. za izjednač. debljine zida WDA MX 270 x 6
El. za izjed. debljine zide WDA MX 270 x 10, Alu

Za prilagodbu debljinama zida.

B

40
50
60
100

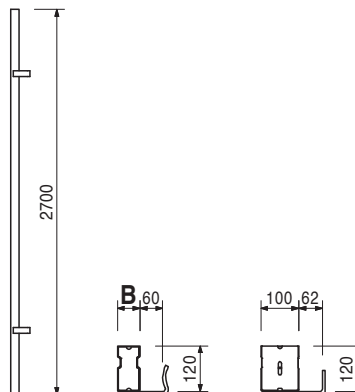

MAXIMO okvirna oplata



br. art.	težina kg
101813	8,050

Profil prilagodne ploče TPP 270, Alu
 Za izjednačavanje prilagodnom pločom 21 mm.

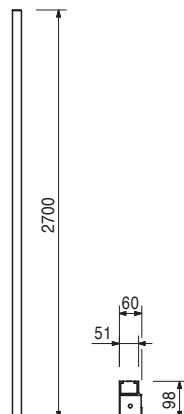

112104	166,000
--------	---------

Element MX 120 x 240
 2,880 m². Element s oplatnom pločom 18 mm.

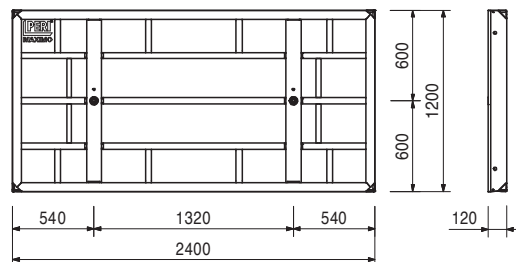
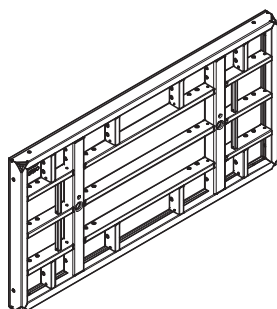

112143	90,700
--------	--------

Element MX 120 x 120
 1,440 m². Element s oplatnom pločom 18 mm.

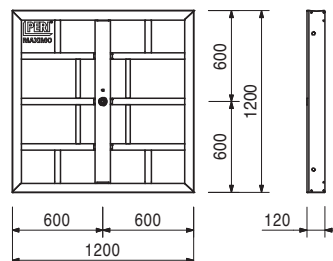
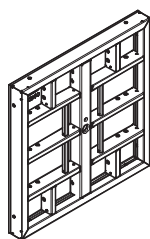

br. art.	težina kg
112152	67,700

Element MX 120 x 90

1,080 m². Element s oplatnom pločom 18 mm.

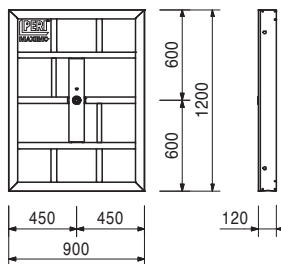
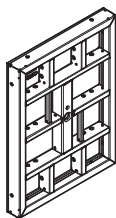

112221	51,200
--------	--------

Element MX 120 x 60

0,720 m². Element s oplatnom pločom 18 mm.

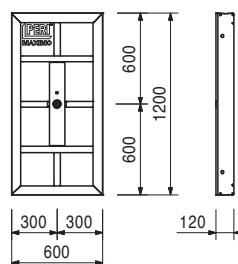

112232	37,100
--------	--------

Element MX 120 x 45

0,540 m². Element s oplatnom pločom 18 mm.

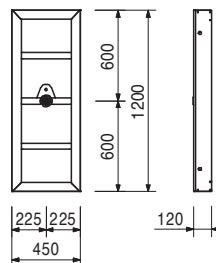

112239	27,400
--------	--------

Element MX 120 x 30

0,360 m². Element s oplatnom pločom 18 mm.

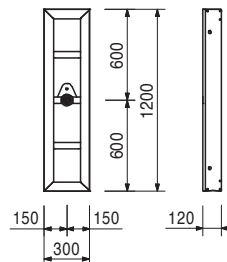

br. art.	težina kg
112850	50,400

Višenamjenski element MXM 120 x 60
 0,720 m². Element s oplatnom pločom 18 mm.
 Za kose kutove, zidne priključke itd.

Komplet s
 11 kom. 116353 čepovi MXM Ø 21
 11 kom. 113998 brtva MXM Ø 16

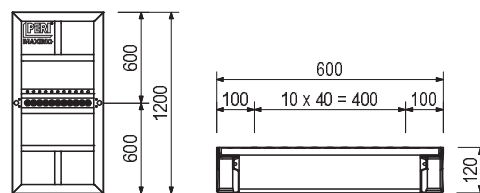
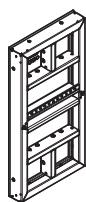

115299	48,500
--------	--------

Unutarnji kutni element MXI 120 x 50/20
 0,840 m². Element s oplatnom pločom 18 mm.
 Za unutarnje kutove od 90°.

Komplet s
 4 kom. 116353 čepovi MXM Ø 21
 4 kom. 113998 brtva MXM Ø 16

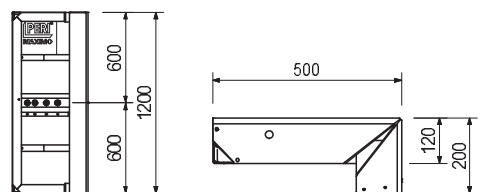
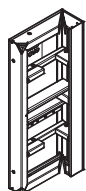

112689	80,500
--------	--------

Unutarnji kutni element MXI 120 x 60
 1,440 m². Element s oplatnom pločom 18 mm.
 Za unutarnje kutove od 90°.

Komplet s

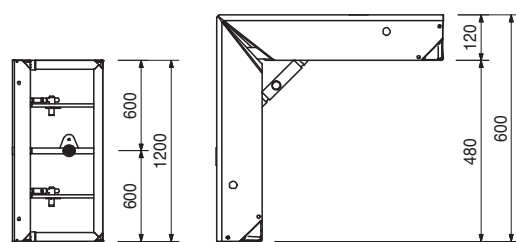
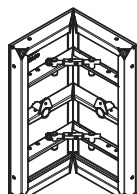

117915	0,000
--------	-------

Kutni element okna MXE 120
 Element za montažu unutarnjih kuteva 90° te za demontažu i premještanje kompletne unutarnje oplata okna.

Sigurnosna uputa
 Nosivost točke preuzimanja opterećenja 2,0 t.

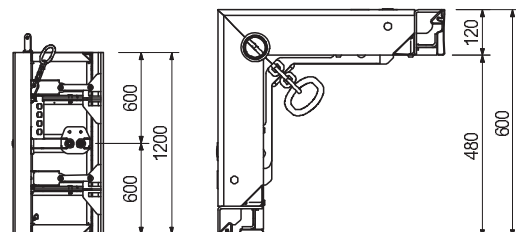
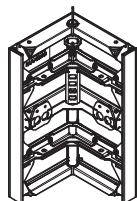

br. art.	težina kg
112888	153,000

Vanjski kutni element MXA 120 x 90

2,160 m². Element s oplatnom pločom 18 mm.
Za vanjske kutove od 90°.

Komplet s

12 kom. 116353 čepovi MXM Ø 21
12 kom. 113998 brtva MXM Ø 16

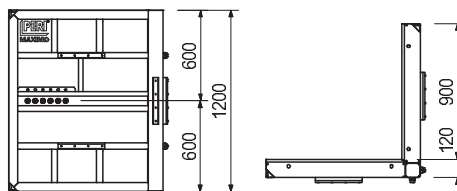
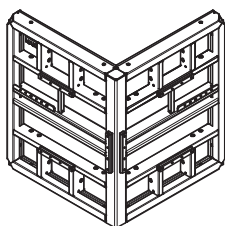

112830	70,300
--------	--------

Vanjski kutni element MXA 120 x 45

1,080 m². Element s oplatnom pločom 18 mm.
Za vanjske kutove od 90°.

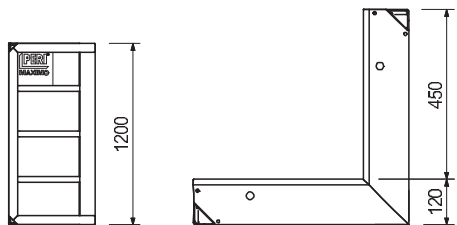

112761	61,200
--------	--------

Vanjski kutni element MXA 120 x 35

0,840 m². Element s oplatnom pločom 18 mm.
Za vanjske kutove od 90°.

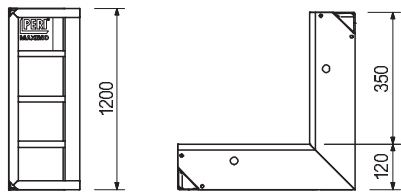
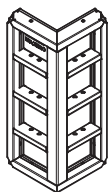

113246	31,200
--------	--------

Zglobni kutni element MXGI 120

0,720 m². Od aluminija.
Za kose kutove od 75° iznutra.

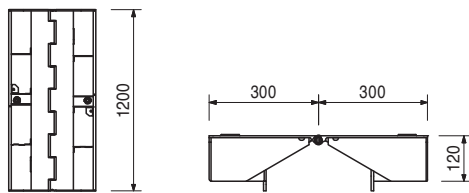
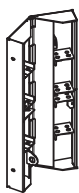

br. art.	težina kg
111850	19,000

Zglobni kutni element MXGA 120

0,360 m². Od aluminija.
Za kose kutove od 75° izvana.

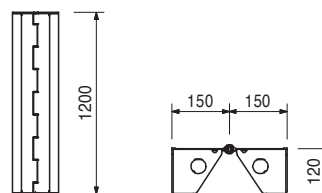

			B
114212	6,430	El. za izjednačavanje debljine zida WDA MX 120	40
114191	6,990	El. za izjednač. debljine zida WDA MX 120 x 4	50
114181	7,480	El. za izjednač. debljine zida WDA MX 120 x 5	60
114142	4,510	El. za izjed. debljine zida WDA MX 120 x 10, Alu	100

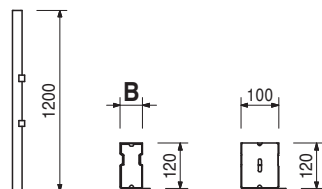

Za prilagodbu debljinama zida.

101823	3,600
--------	-------

Profil prilagodne ploče TPP 120, Alu

Za izjednačavanje prilagodnom pločom 21 mm.

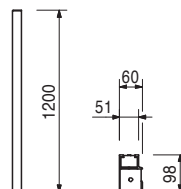

112115	121,000
--------	---------

Element MX 90 x 240

2,160 m². Element s oplatnom pločom 18 mm.

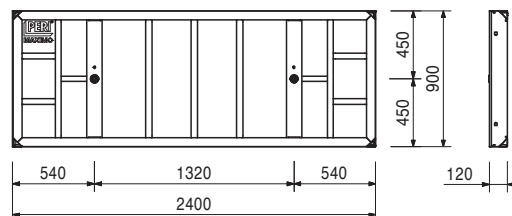
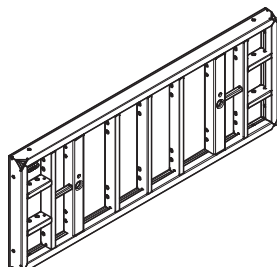

br. art.	težina kg
112252	48,900

Element MX 90 x 90

0,810 m². Element s oplatnom pločom 18 mm.

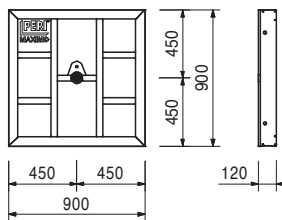
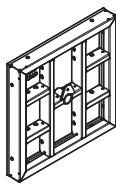

112259	36,600
--------	--------

Element MX 90 x 60

0,540 m². Element s oplatnom pločom 18 mm.

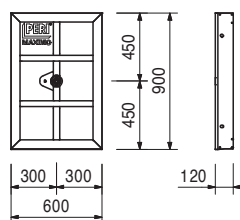
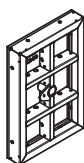

112265	31,200
--------	--------

Element MX 90 x 45

0,405 m². Element s oplatnom pločom 18 mm.

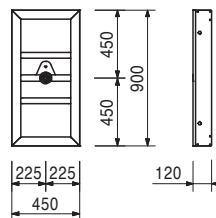

112271	22,000
--------	--------

Element MX 90 x 30

0,270 m². Element s oplatnom pločom 18 mm.

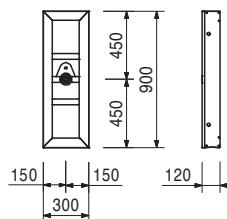

br. art.	težina kg
115307	36,600

Unutarnji kutni element MXI 90 x 50/20
 0,630 m². Element s oplatnom pločom 18 mm.
 Za unutarnje kutove od 90°.



Komplet s
 4 kom. 116353 čepovi MXM Ø 21
 4 kom. 113998 brtva MXM Ø 16

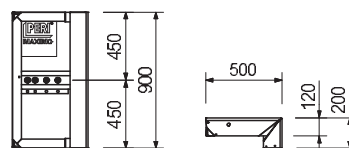

112715	68,100
--------	--------

Unutarnji kutni element MXI 90 x 60
 1,080 m². Element s oplatnom pločom 18 mm.
 Za unutarnje kutove od 90°.

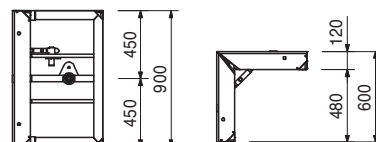
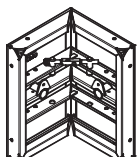

112889	133,000
--------	---------

Vanjski kutni element MXA 90 x 90
 1,620 m². Element s oplatnom pločom 18 mm.
 Za vanjske kutove od 90°.

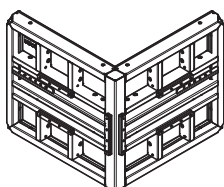

Komplet s
 12 kom. 116353 čepovi MXM Ø 21
 12 kom. 113998 brtva MXM Ø 16

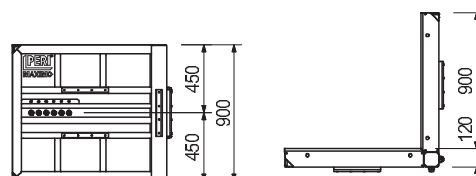

112126	88,100
--------	--------

Element MX 60 x 240
 1,440 m². Element s oplatnom pločom 18 mm.

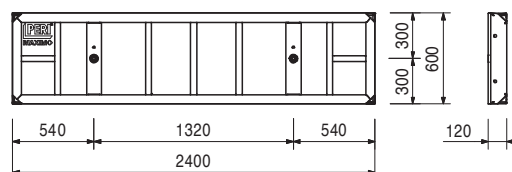
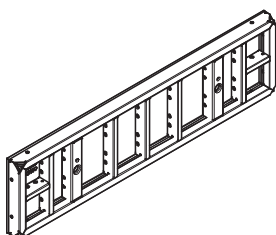

112280	28,400
--------	--------

Element MX 60 x 60
 0,360 m². Element s oplatnom pločom 18 mm.

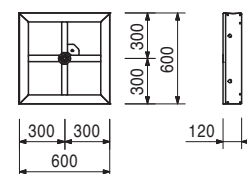
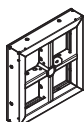

br. art.	težina kg
112286	21,900

Element MX 60 x 45

0,270 m². Element s oplatnom pločom 18 mm.

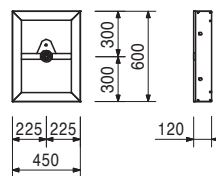

112292	16,200
--------	--------

Element MX 60 x 30

0,180 m². Element s oplatnom pločom 18 mm.

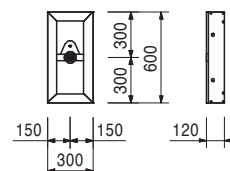

115315	29,400
--------	--------

Unutarnji kutni element MXI 60 x 50/20

0,420 m². Element s oplatnom pločom 18 mm.

Za unutarnje kutove od 90°.



Komplet s

4 kom. 116353 čepovi MXM Ø 21

4 kom. 113998 brtva MXM Ø 16

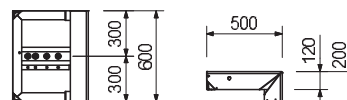

112726	45,400
--------	--------

Unutarnji kutni element MXI 60 x 60

0,720 m². Element s oplatnom pločom 18 mm.

Za unutarnje kutove od 90°.

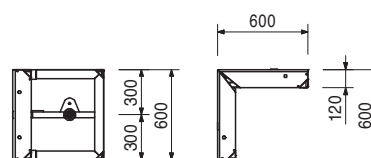
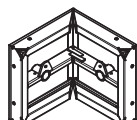

112822	83,700
--------	--------

Vanjski kutni element MXA 60 x 90

1,080 m². Element s oplatnom pločom 18 mm.

Za vanjske kutove od 90°.

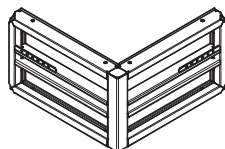

Komplet s

12 kom. 116353 čepovi MXM Ø 21

12 kom. 113998 brtva MXM Ø 16

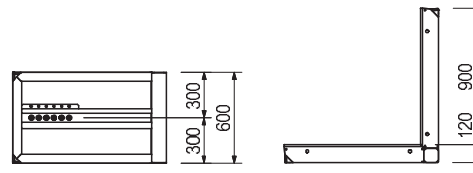

br. art.	težina kg
112837	40,200

Vanjski kutni element MXA 60 x 45
 0,540 m². Element s oplatnom pločom 18 mm.
 Za vanjski kut od 90°.

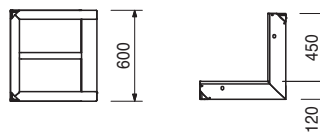

112778	34,900
--------	--------

Vanjski kutni element MXA 60 x 35
 0,420 m². Element s oplatnom pločom 18 mm.
 Za vanjski kut od 90°.

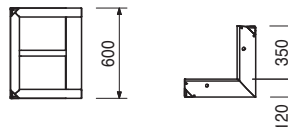

112133	52,900
--------	--------

Element MX 30 x 240
 0,720 m². Element s oplatnom pločom 18 mm.

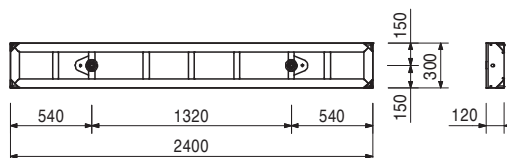
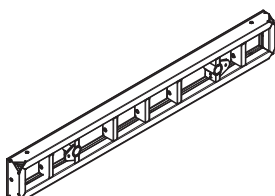

113847	3,960
--------	-------

MX sidro 15-25
 Za debljine zida 15 - 25 cm.

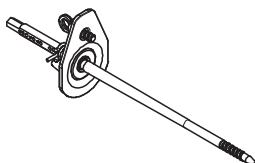

Uputa
 Za lakšu demontažu prije svake uporabe
 poprskati sredstvom za skidanje betona.
Tehnički podaci
 Dopuštena vlačna sila 90 kN.

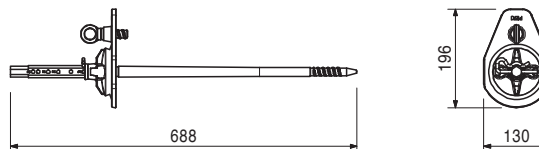

112387	4,090
--------	-------

MX sidro 20-30
 Za debljine zida 20 - 30 cm.

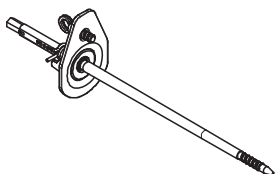

Uputa
 Za lakšu demontažu prije svake uporabe
 poprskati sredstvom za skidanje betona.
Tehnički podaci
 Dopuštena vlačna sila 90 kN.

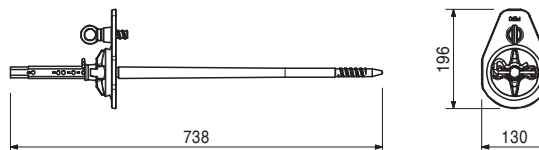

MAXIMO okvirna oplata



br. art.	težina kg
112464	4,350

MX sidro 30-40
Za debljine zida 30 - 40 cm.

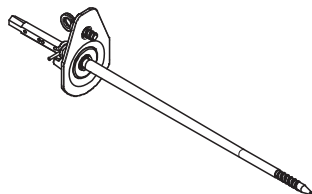

Uputa
Za lakšu demontažu prije svake uporabe poprskati sredstvom za skidanje betona.

Tehnički podaci
Dopuštena vlačna sila 90 kN.

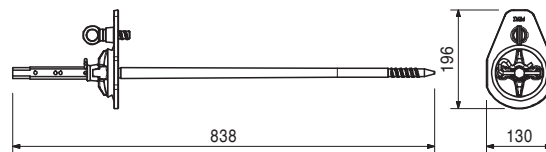

112386	2,560
--------	-------

MX zglobna matica
Protumatica za sidro MX.



Tehnički podaci
Dopuštena vlačna sila 90 kN.

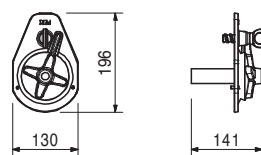

116841	1,900
--------	-------

MX ključ za sidra-2
Za lakše oslobađanje MX sidra.

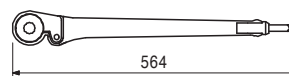
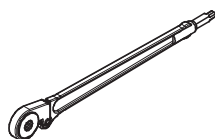

116353	0,004
--------	-------

Čepovi MXM Ø 21
Za MAXIMO višenamjenske elemente MXM, unutarnje kutne elemente 50/20, vanjske kutne elemente 90 i standardne elemente kod jednostrane uporabe.

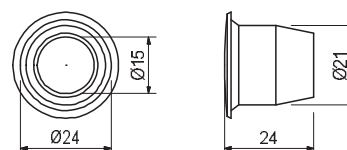

114300	0,002
--------	-------

Čepovi MX Ø 17,5 - 22
Za zatvaranje sidrenih otvora MX u betonu.

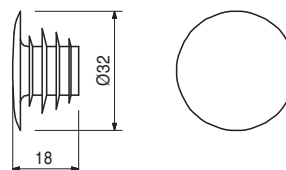

br. art.	težina kg
023500	4,350

Spojnica BFD, poc.

Za sve spojeve elemenata kod MAXIMO, TRIO i RUNDFLEX sistema. Izjednačavanja do 10 cm.

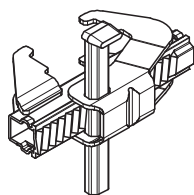

Tehnički podaci

Dopuštena vlačna sila 20,0 kN.

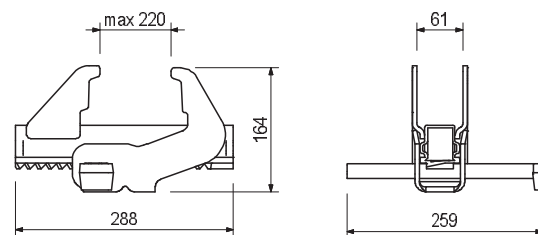

114034	13,800
--------	--------

Profil za izjednačavanje MAR 85-2.

Za izjednačavanja dužine, nadogradnje, čeone oplate i specijalne primjene kod MAXIMO oplate. Priključni dijelovi ne mogu se izgubiti.

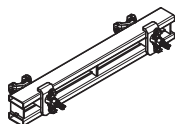

Tehnički podaci

Dopušteni moment progiba 3,9 kNm.

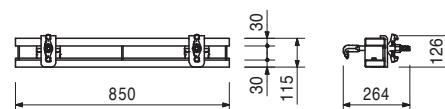

114036	23,000
--------	--------

Profil za izjednačavanje MAR 170-2

Za izjednačavanja dužine, nadogradnje, čeone oplate i specijalne primjene kod MAXIMO oplate. Priključni dijelovi ne mogu se izgubiti.

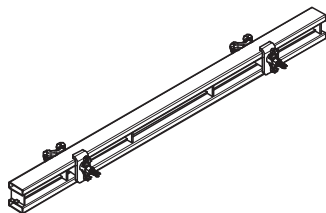

Tehnički podaci

Dopušteni moment progiba 3,9 kNm.

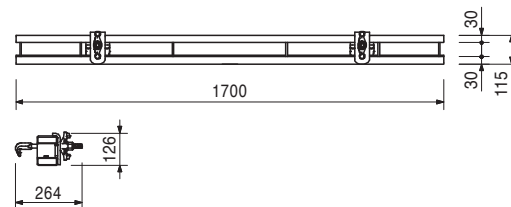

023551	8,520
--------	-------

Profil 85

Odgovara profilu za izjednačavanje TAR 85, ali je bez ovesne kuke.

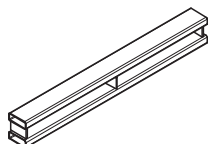

Tehnički podaci

Dopušteni moment progiba 4,4 kNm.

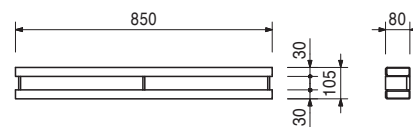

023820	0,375
--------	-------

Zatezna glava s kukom DW 15, poc.

Za priključak pribora na MAXIMO i TRIO elemente. Navoj DW 15.



Tehnički podaci

Dopuštena vlačna sila 20,0 kN.

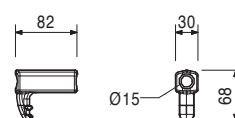

br. art.	težina kg
023650	0,769

Zatezna kuka DW 15 l = 400, poc.

Za priključak pribora na MAXIMO i TRIO elemente. Navoj DW 15.

Tehnički podaci

Dopuštena vlačna sila 20,0 kN.

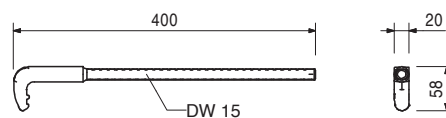
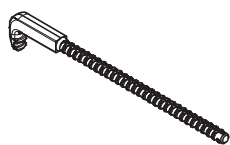

023640	1,140
--------	-------

Čeono sidro TS, poc.

Za uvođenje sila iz čeonih oplata u MAXIMO i TRIO elemente. Navoj DW 15.

Tehnički podaci

Dopuštena vlačna sila 20,0 kN.

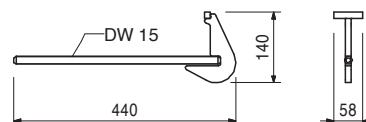
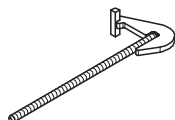

115640	6,000
--------	-------

Čeono sidro MX DW20

Za montažu zidnih pomaka kod MAXIMO oplata, zajedno s višenamjenskim elementom MXM.

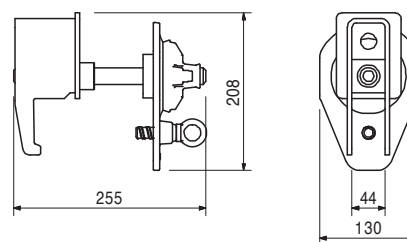
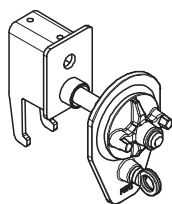

023660	3,310
--------	-------

Stezna glava TRIO, poc.

Za priključak kosnika i stabilizatora na MAXIMO i TRIO elemente. Montaža na horizontalnim i vertikalnim profilima.

Komplet s

1 kom. 027170 svornjak 16 x 42, poc.

1 kom. 018060 opružni nosač 4/1, poc.

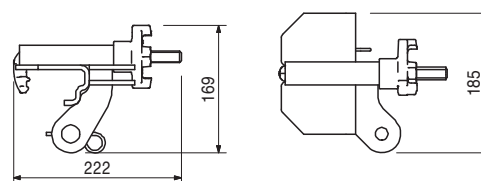
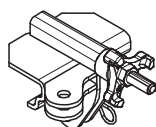

br. art.	težina kg
115350	6,430

Tlačna i vlačna razupora MX

Za uporabu kod oplata temelja do 1,20 m visine te kao zamjena gornjeg sidra kod MAXIMO 330.

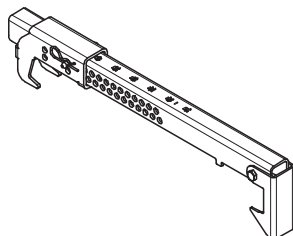

Komplet s

1 kom. 115331

1 kom. 018060 opružni osigurač 4/1, poc.

Uputa

Podesivo od 15 do 30 cm u rasteru od 0,5 te od 30 do 40 cm u rasteru od 1 cm.

Tehnički podaci

Dopuštena vlačna i tlačna sila 9 kN.

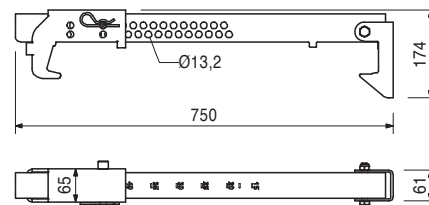

112588	5,520
--------	-------

Poluga za demontažu TRIO

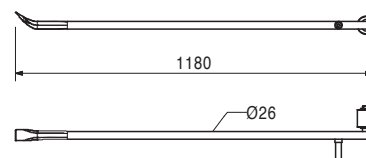
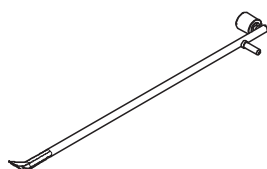

117321	31,000
--------	--------

Kombi ovjes MX

Za transport MAXIMO i TRIO naslaga elemenata. Za ovjes kuke za premještanje MAXIMO 1,5 t i kutije za slaganje MAXIMO.

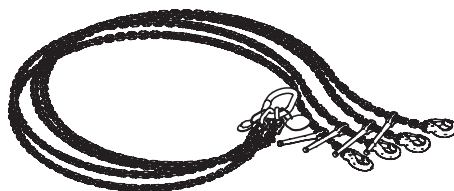

Sigurnosna uputa

Voditi računa o uputama za uporabu!

117322	25,000
--------	--------

Transportni ovjes MX

Za transport MAXIMO i TRIO naslaga elemenata.

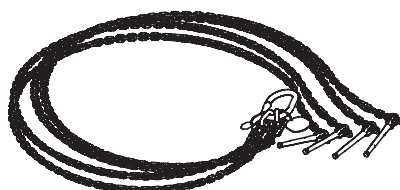

Sigurnosna uputa

Voditi računa o uputama za uporabu!

br. art.	težina kg
115168	7,720

Kuka za premještanje MAXIMO 1,5 t
 Za transport MAXIMO i TRIO elemenata.

Sigurnosna uputa

Rabiti 2 komada po transportnoj jedinici.
 Voditi računa o uputama za rukovanje.
 Nosivost:
 - čelični elementi 1,5 t
 - aluminijски elementi 750 kg

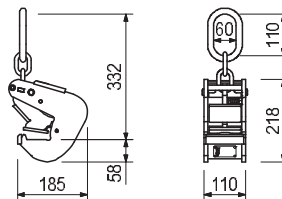

115058	7,490
--------	-------

Kutija za slaganje MAXIMO
 Za slaganje i transportiranje 2 - 5 MAXIMO ili TRIO elemenata svake veličine. Za transport dizalicom i viličarom. 4 komada po naslazi.

Sigurnosna uputa

Voditi računa o uputama za rukovanje.
 Nosivost 500 kg po kutiji za slaganje,
 2 t po naslazi.

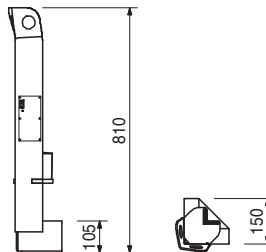

113019	0,068
--------	-------

Pomoćni element za slaganje MX
 Za jednostavno slaganje MAXIMO elemenata.

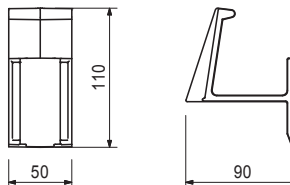
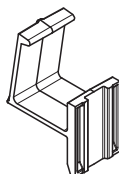

023440	0,312
--------	-------

Pomoćni element za premještanje TRIO
 Za jednostavno premještanje TRIO elemenata.

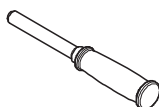

br. art.	težina kg
023670	12,800

Konzolna skela TRG 80

Za montažu radne skele i skele za betoniranje kod MAXIMO i TRIO sistema. Montaža na horizontalnim i vertikalnim profilima.

Uputa

Automatski osigurana ovjesom.

Tehnički podaci

Dopušteno opterećenje 150 kg/m² pri maksimalnoj utjecajnoj širini od 1,35 m.

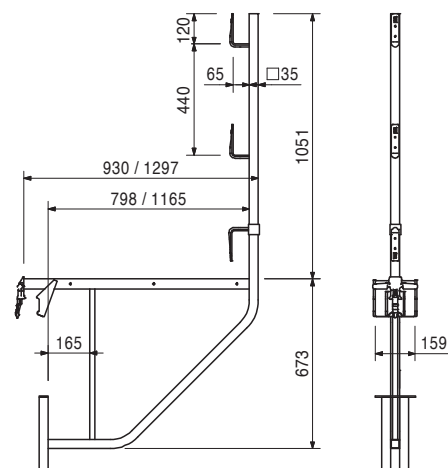
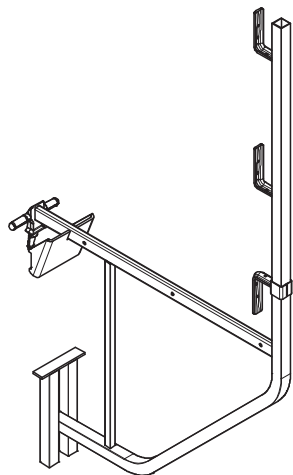

023680	17,000
--------	--------

Konzolna skela TRG 120

Za montažu radne skele i skele za betoniranje kod MAXIMO i TRIO sistema. Montaža na horizontalnim i vertikalnim profilima.

Uputa

Automatski osigurana ovjesom.

Tehnički podaci

Dopušteno opterećenje 150 kg/m² pri maksimalnoj utjecajnoj širini od 1,35 m.

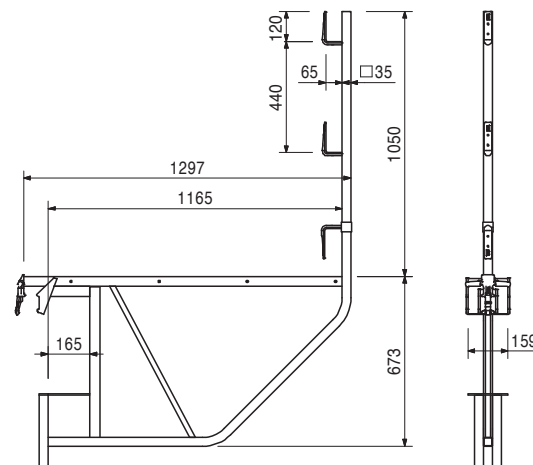
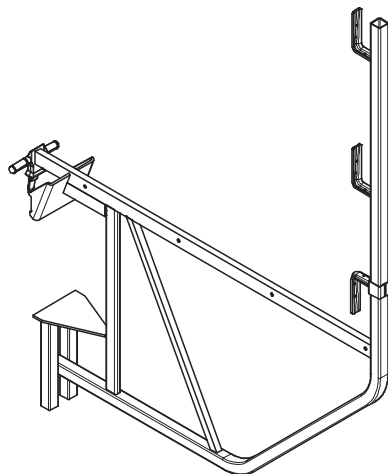

br. art.	težina kg
022950	129,000

Podest za betoniranje TRIO 120 x 270

Radna skela i skela za betoniranje za MAXIMO i TRIO. Ovjesi se na element s gornje strane, samoosiguravajući.

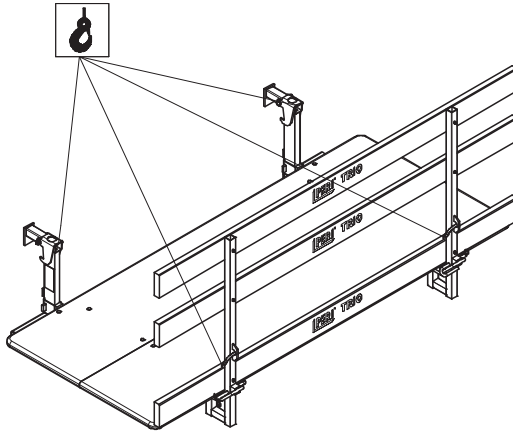

Uputa

Uvijek premještati pomoću 4-strukog ovjesa. Točke ovjesa za dizalicu označene su žutom bojom.

Tehnički podaci

Dopušteno opterećenje 150 kg/m².

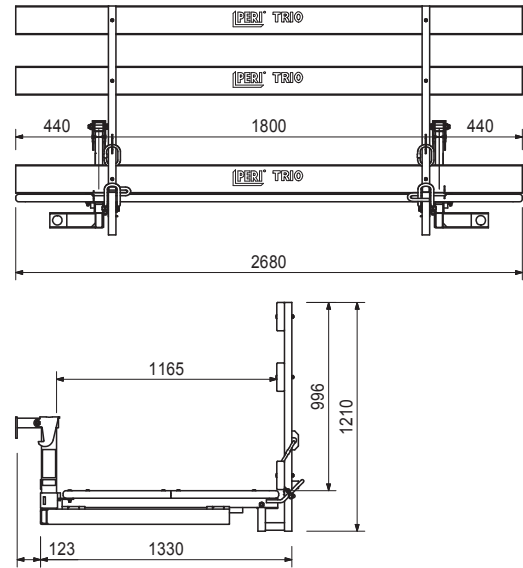

027680	49,600
--------	--------

Priključna šina SB-1, 2 - MX/TR/D

Za montažu okvirnog podupirača jednostrane oplata SB-1, 2 na MAXIMO, TRIO i DOMINO elemente.



Sigurnosna uputa

Nosivost točke preuzimanja opterećenja 1,0 t pri nagibnom kutu ovjesa $\leq 15^\circ$.

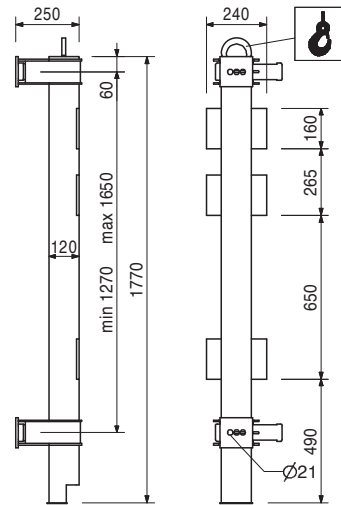

Pribor

027690	0,368
027590	2,400
113255	0,414
114107	1,250

Svornjak SB-TRIO/DOMINO, poc.

Kukasta spojnica SB-1, 2

Svornjak SB-MAXIMO, poc.

Čahura SB-MAXIMO, poc.

br. art.	težina kg
025740	9,140

Priključak SB-A, B, C - MX/TR/D

Za povezivanje MAXIMO, TRIO i DOMINO elemenata s okvirnim podupiračem jednostrane oplata SB-A0, A, B, C.

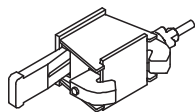

Uputa

1 komad po sidrenoj poziciji.

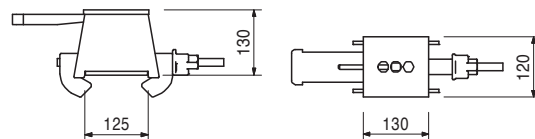

027690	0,368
113255	0,433
114107	1,250

Pribor

Svornjak SB-TRIO/DOMINO, poc.

Svornjak SB-MAXIMO, poc.

Čahura SB-MAXIMO, poc.

113255	0,414
--------	-------

Svornjak SB-MAXIMO, poc.

Za povezivanje MAXIMO elemenata s okvirnim podupiračem jednostrane oplata SB.

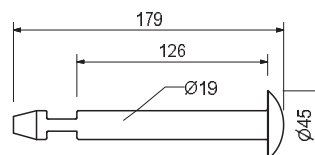
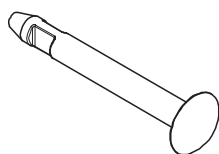

114107	1,250
--------	-------

Pribor

Čahura SB-MAXIMO, poc.

114107	1,250
--------	-------

Čahura SB-MAXIMO, poc.

Za povezivanje MAXIMO elemenata s okvirnim podupiračem jednostrane oplata SB.

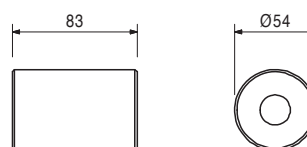
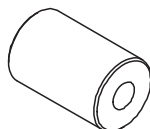

113255	0,414
--------	-------

Pribor

Svornjak SB-MAXIMO, poc.

114509	0,057
--------	-------

Vijčani čepovi MX 84 MF

Za zatvaranje sidrenih otvora MX u betonu.

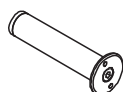

Uputa

Primjena kod pojave tlačne vode (vodonepropusni beton).
Postoji ispitni izvještaj!

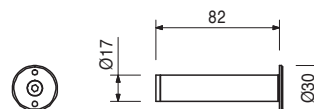

br. art.	težina kg
114496	0,043

Vijčani čepovi MX 50 MF
 Za zatvaranje sidrenih otvora MX u betonu.

Uputa
 Primjena kod vode koja nije pod tlakom.

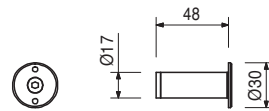

114503	0,036
--------	-------

Vijčani čepovi MX 50 OF
 Za zatvaranje sidrenih otvora MX u betonu ako prirubnica ne smije biti vidljiva.

Uputa
 Primjena kod vode koja nije pod tlakom.

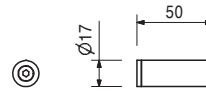

114619	0,037
--------	-------

Natični ključ MX
 Za držanje vijčanih čepova MX 84 MF i MX 50 MF.

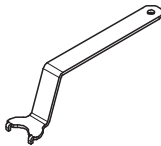
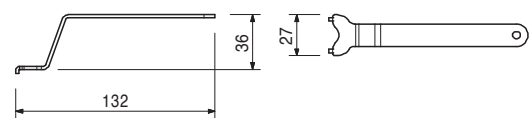

112937	0,184
--------	-------

Magnetni konus MX 55
 Za uporabu kod MAXIMO oplata.
 Primjena sa sidrom MX.

Uputa
 Primjena kod vodonepropusnog i vidnog betona.
 Ugrađuje se obostrano.

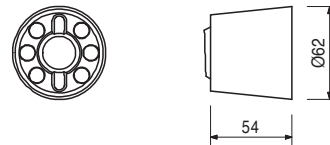

114797	0,893
--------	-------

Pribor
Ključ za magnetni konus MX

031643	0,265
--------	-------

DK betonski konus UNI 58/52
 Za zatvaranje sidrenih pozicija DK brtvenim konusom DW 15/55, DW 20/55, DW 26/55 i SK sidrenim konusom DW 15.

Uputa
 Jedinica isporuke 50 komada.

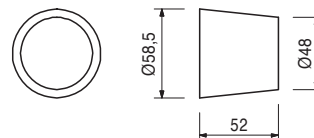
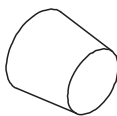

br. art.	težina kg
114797	0,893

Ključ za magnetni konus MX

Za demontažu magnetnog konusa MX 55.

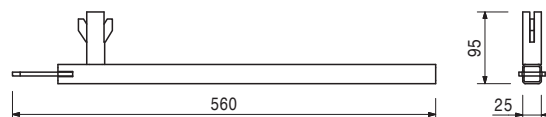
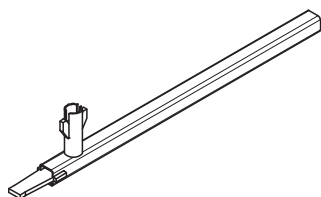

114592	0,021
--------	-------

Razmačni prsten MX 10 mm

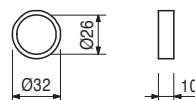

113018	0,012
--------	-------

Konus MX DR 22

Za uporabu sidara DW 15.
Odgovara juvidur cijevi DR 22.

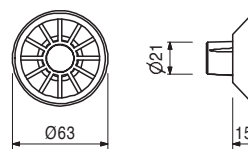

031637	0,055
--------	-------

DK brtveni konus DW 20/55

Za vodonepropusne, vatrootporne i zvučno izolacijske sidrene pozicije sa sidrom DW 20.
Primjena s juvidur cijevi 28.

Uputa

Jedinica isporuke 50 komada.

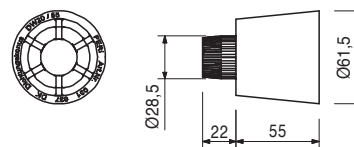
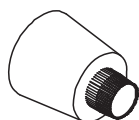

112342	0,077
--------	-------

Brtena čahura MX Ø 16

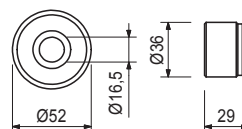

br. art.	težina kg	
112338	0,011	Matica brtvena čahure MX Ø 16

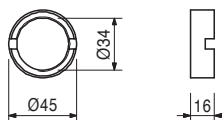

Pribor

109768	0,080	Ljepilo AN 302-60, 50 ml
--------	-------	---------------------------------

109768	0,080	Ljepilo AN 302-60, 50 ml Dovoljno za oko 75 komada, matica brtvene čahure MX Ø 16.
--------	-------	---

113183	0,556	Ključ brtvene čahure MX Ø 16
--------	-------	-------------------------------------

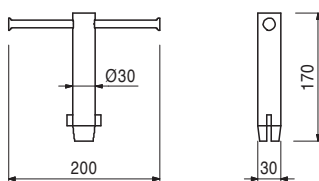
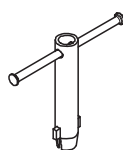

113998	0,005	Brtva MXM Ø 16 Za MAXIMO višenamjenski element MXM.
--------	-------	---

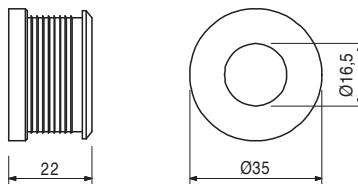
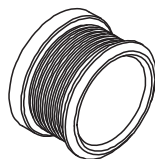

PERI program



Zidne oplata

Okvirna oplata
Oplata s nosačima
Kružna oplata
Oplata za fasadu
Okvirni podupirači
Jednostrane oplata



Penjajući sistemi

Penjajuća skela
Samopenjajući sistemi
Penjajući zaštitni zid
Sistemi podesta



Oplata stupa

Kvadratne
Pravokutne
Kružne

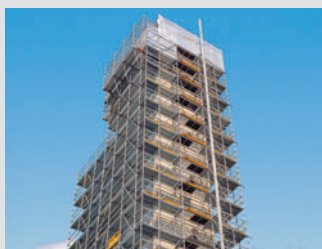

Skele, stepeništa, radni podesti

Fasadne skele
Radni podesti
Krov za zaštitu od vremenskih utjecaja
Pristup stepeništu



Stropne oplata

Panelne oplata
Oplata s roštiljnim nosačima
Oplata s nosačima
Stropni stolovi
Oplata greda



Oplata za mostove i tunele

Kolica za montažu vijenca
Podest za montažu vijenca
Inženjerski moduli



Nosive skele

Čelični stropni podupirači
Aluminijski stropni podupirači
Toranjski sistemi
Podupirači za teška opterećenja



Servisne usluge

Montaža oplata
Čišćenje/popravci
Projektiranje oplata
Software
Statika
Specijalne konstrukcije

Ostali sistemi

Sigurnosni sistemi
Oplatne ploče
Nosaji oplata
Sistemi za demontažu
Palete
Transportne kutije



PERI oplata i skele d.o.o.

Dolenica 20
10 250 Donji Stupnik/Hrvatska
Tel.: +385 (0)1.655 36 36
Fax: +385 (0)1.655 36 37
info@peri.com.hr
www.peri.com.hr